



Printable Solutions

- Maxi Frames
- River Maxi Frame
- Bay Maxi Frame
- Gulf Maxi Frame
- Lagoon Maxi Frame
- Ocean Maxi Frame
- Maxi Frame with LED
- Semi Products for Maxi Frame
- Omni Frame
- Omni A Board

- Maxi Rahmen
- River Maxi Rahmen
- Bay Maxi Rahmen
- Gulf Maxi Rahmen
- Lagoon Maxi Rahmen
- Ocean Maxi Rahmen
- Maxi Frame with LED
- Ersatzteile für Maxi Rahmen
- Omni Rahmen
- Omni Kundenstopper



Maxi Frames



It offers a fresh new look to today's display atmosphere which is an alternative to frame systems, Banners, Pop-Ups by applying a printed fabric's installation into the Maxi profile with a sewed or taped nylon strip. The product is a stunning combination of Aluminum and Digital Printing Machines where they unite with a fabric. The attractive point of the product is when it is looked at the front side, you are unable to see the Aluminium Parts of the frame which makes it look frameless.

The details of packaging of the product are:

- All the MAXI FRAMES are individually packed.
- Profiles and connector parts for the required sizes are boxed unassembled.
- Nylon strip is included in each frame.
- Fixing tools are included in each package. Just the feet for Double Sided Ocean Maxi frame must be ordered separately and 4 feet models are available.

Our Maxi Frame Range consists of mainly 5 different profile options. These profiles are designed to make 3 different models of Single Sided MAXI FRAMES, and 2 models of Double Sided MAXI FRAMES. Our standard Maxi Frames are always supplied unassembled providing connectors, hanging parts, and nylon strips. For the double sided ceiling hanger model the hanging wire cable system in each box. Please note, ceiling hanger and 4 feet options should be ordered separately.

MAXI FRAME ist ein neues Highlight in der Welt der Displaysysteme und eine interessante Alternative zu herkömmlichen Rahmen-Banner, oder Pop-Up Systemen. Die Textilgrafik wird dabei mittels eines angenähten Silikonkeder einfach in die Rahmennut gesteckt. Der Clou hierbei ist die perfekte Illusion der Rahmenlosigkeit durch gerade einmal 2 mm sichtbares Profil.

Und so wird Maxi Frame geliefert:

- Alle MAXI FRAME werden einzeln verpackt.
- Profile und Verbinder für die entsprechenden Rahmengrößen werden unmontiert, separat verpackt mitgeliefert.
- Der auf die Rahmengröße zugeschnittene Silikonkeder wird mitgeliefert.
- Das für Deckenabhängung von doppelseitigen Rahmen benötigte Abhänge-Set ist im Lieferumfang enthalten. Bei freistehender Anwendung, muß das gewünschte Fuß-Set 2 sind auch 4 Fussversionen möglich separat bestellt werden.

Das MAXI FRAME System besteht aus 5 Profilvarianten, von denen 3 für die einseitige Anwendung und 2 für doppelseitige Anwendungen entwickelt wurden. Es wird grundsätzlich demontiert mit Eckverbindern, Quertraversen mit Schlössern und passendem Silikonkeder geliefert. Bei doppelseitigen Rahmen ist das Deckenabhänge-Set im Lieferumfang enthalten. Das Zubehör für Wandmontage sowie die Fuß-Lösungen für doppelseitige Rahmen mit Füßen müssen separat bestellt werden.



Maxi Frames



Single Sided MAXI FRAMES are provided in 3 different profiles in order of thickness:

a) Valet Profile: 15x22 mm profile. The Single Sided MAXI FRAMES made up with Valet Profile are named as RIVER MAXI FRAMES. Available Poster Sizes are: A4, A3, A2, A1, B2, B1, and 50x100cm.

b) Ace Profile: 32x8mm profile. The Single Sided MAXI FRAMES made up with Ace Profile are named as BAY MAXI FRAMES. Available Poster Sizes are: A4, A3, A2, A1, A0, B2, B1, B0, 50x10cm., 100x100cm., 100x150cm., and 100x200cm.

c) Dame Profile: 34x32 mm profile. The Single Sided MAXI FRAMES made up with Dame Profile are named as GULF MAXI FRAMES. Available Poster Sizes are: 100x200cm., 100x300cm., 150x200cm., 150x300cm., 200x200cm., and 200x300cm.

Double Sided MAXI FRAMES are provided in 2 different profiles.

a) Queen Profile: 45x15 mm profile - Suitable for ceiling suspension. The Double Sided MAXI FRAMES made up with Queen Profile are named as LAGOON MAXI FRAMES. Available Poster Sizes are: A4, A3, A2, A1, A0, B2, B1, B0, 50x10cm., 100x100cm., 100x150cm., and 100x200cm.

b) King Profile: 50x40 mm profile - Designed with feet for free standing. The Double Sided MAXI FRAMES made up with King Profile are named as OCEAN MAXI FRAMES. Available Poster Sizes are: 100x140cm., 100x150cm., 100x200cm., 100x225cm., 200x150cm., 200x200cm., 200x225cm., 300x150cm., 300x200cm., and 300x225cm.

We offer MAXI FRAMES both in standard sizes boxed unassembled and also in lengths and parts as semi products.

Find below all the Semi-Products that are used in MAXI FRAMES.

Clear Nylon Strip, Corner Cleat for MAXI FRAMES, Straight Cleat for H-Profile of MAXI FRAME, Square Corner Connector for MAXI FRAME, L-Type Corner Connector for MAXI FRAME, Hanging System including wire cable, Transparent or Gray Color Pull strip.

Find below the names of 4 different feet models:
Circle Feet, Hoop Feet, Baseball Feet, and Fillet Feet.

Für einseitige MAXI FRAMES können je nach Größe folgende Profile verwendet werden:

a) Valet Profil: 15x22 mm Profil. Die aus Valet-Profil bestehenden, einseitigen Rahmen werden RIVER MAXI FRAMES genannt und sind in DIN A4 bis DIN A1 sowie B2 bis B1 und 50x100 cm erhältlich.

b) Ace Profil: 32x8 mm Profil. Die aus Ace-Profil bestehenden, einseitigen Rahmen werden BAY MAXI FRAMES genannt und sind in DIN A4 bis DIN A0 sowie B2 bis B0 und 50x100 cm, 100x100 cm, 100x150 cm und 100x200 cm erhältlich.

c) Dame Profil: 34x32 mm Profil. Die aus Dame-Profil bestehenden, einseitigen Rahmen werden GULF MAXI FRAMES genannt und sind in 100x200 cm, 100x300 cm, 150x200 cm, 150x300 cm, 200x200 cm und 200x300 cm erhältlich.

Für doppelseitige MAXI FRAMES können je nach Größe folgende Profile verwendet werden:

a) Queen-Profil: 45x15 mm Profil. Die aus Queen-Profil bestehenden, doppelseitigen Rahmen werden LAGOON MAXI FRAMES genannt und sind in DIN A4 bis DIN A0 sowie B2 bis B0 und 50x100 cm, 100x100 cm, 100x150 cm und 100x200 cm erhältlich.

b) King-Profil: 50x40 mm Profil. Die aus King-Profil bestehenden, doppelseitigen Rahmen werden OCEAN MAXI FRAMES genannt und sind in 100x140 cm, 100x150 cm, 100x200 cm, 100x225 cm, 200x150 cm, 200x200 cm und 200x225, 300x150 cm, 300x200 cm und 300x225 cm erhältlich.

MAXI FRAMES werden sowohl in Standardgrößen unmontiert, als auch als Bausatz bestehend aus Profilen mit Zubehör geliefert.

Das gesamte Zubehör für MAXI FRAME besteht aus:

Silikonkeder, 45 Grad Schloss für Eckverbindung der Rahmen, gerades Schloss für Quertraversen, Rechteck-Eckverbinder für Rahmen, L-Eckverbinder für Rahmen, Drahtseil-Abhängeset, graue oder transparente Lasche zum Herausziehen der Grafik aus dem System.

Folgende Fußlösungen für MAXI FRAME sind erhältlich:
Kreis-Fuß, Baseball-Fuß, Oval-Fuß und Teller-Fuß.



River Maxi Single Sided



Valet Profile / 15x22 mm River Maxi Frame

The single-sided MAXI FRAMES that are made up of Valet Profile are named RIVER MAXI FRAMES.

Valet Profil / 15x22 mm River Maxi Frame

Die aus Valet-Profil bestehenden, einseitigen Rahmen werden RIVER MAXIFRAMES genannt.



Hang by using the assembling holes.
Aufhängung durch die Verbindungslöcher



The thickness of the channel is 4 mm. Supplied nylon strip is 3 mm, recommended fabric thickness for digital printing is 0,5 mm. The pull sticker in 0,5 mm thickness must be sewed on the fabric to take out the poster from channels.
Die Kanalbreite ist 4 mm. Die Silikonkeder ist 3 mm dick, somit wird als Textilgrafik für den Digitaldruck 0,5 mm dicker Stoff empfohlen. Die transparente Lasche ist 0,5 mm dick und muss an eine Seite des Stoffes genäht werden, um das Herausziehen der Grafik zu ermöglichen.



13 mm on each side of the fabric into Maxi Profiles, in total 26 mm on each Fabric Poster is not seen on the poster. Please arrange accordingly. Fabric is not included within the original pack.
13 mm von jeder Stoffseite wird in die Rahmennut der Maxi Profile gesteckt, somit werden insgesamt 26 mm des Posterstoffes nicht sichtbar sein. Stoffmass entsprechend anlegen. Der Stoff ist in den Produktpaketen nicht inbegriffen

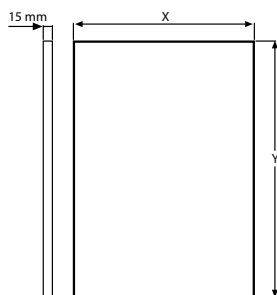

Valet Profile

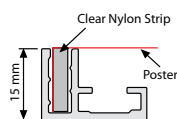

Clear Nylon Strip



Suggested additional print shares for Maxi Frame's Fabric Posters

Between 200 - 750 mm	28 mm
Between 750 - 1500 mm	20 mm
Between 1500 - 3000 mm	15 mm

e.g. Maxi frame size: 1000x300 mm printed fabric size must be 1020x328 mm. But these values might vary according to the fabric material used.

z.B bei einer Maxi Frame Grösse von 1000x300 mm muss die Grösse der bedruckten Textilgrafik 1020x328 mm, sein Diese Angaben können je nach benutzter Stoffqualität differieren.

MATERIAL : Silver anodised aluminium

ARTICLE	EXTERNAL (x-y)	WEIGHT	PACKING SIZE
		WITH PACKING	*W X H X D
UMFR0000A4	210 X 297 mm	0,510 kg	45 X 350 X 70 mm
UMFR0000A3	297 X 420 mm	0,635 kg	45 X 470 X 70 mm
UMFR0000A2	420 X 594 mm	0,810 kg	45 X 650 X 70 mm
UMFR0000A1	594 X 841 mm	1,095 kg	45 X 890 X 70 mm
UMFR0000B2	500 X 700 mm	0,910 kg	45 X 750 X 70 mm
UMFR0000B1	700 X 1000 mm	1,230 kg	45 X 1050 X 70 mm
UMFR0000510	500 X 1000 mm	1,130 kg	45 X 1050 X 70 mm

* W:Width H: Height D: Depth



Bay Maxi Single Sided



Ace Profile / 32x8 mm Bay Maxi Frame

The single-sided MAXI FRAMES that are made up of Ace Profile are named BAY MAXI FRAMES.

Ace Profil / 32x8 mm Bay Maxi Frame

Die aus Ace-Profil bestehenden, einseitigen Rahmen werden BAY MAXIFRAMES genannt.

Hang by using the Square Corner Connector pieces. For larger sizes of Bay Maxi Frame, H-Profile is included in the pack with the quantities shown in the table. *Aufhängung durch die Eckverbinder. Für Größere Grössen des Bay Maxi Rahmens werden Quertraversen in den Produkten beigelegt. Anzahl der Quertraversen können Sie u.g Tabelle entnehmen.*

The thickness of the channel is 4mm. Supplied nylon strip is 3 mm, so recommended fabric thickness for digital printing is 0,5 mm. The pull sticker in 0,5 mm thickness must be sewed on the fabric for taking out the poster when fitted into the channels. *Die Kanalbreite ist 4 mm. Die Silikonkeder ist 3 mm dick, somit wird als Textilgrafik für den Digitaldruck 0,5 mm dicker Stoff empfohlen. Die transparente Lasche ist 0,5 mm dick und muss an eine Seite des Stoffes genäht werden, um das Herausziehen der Grafik zu ermöglichen.*

13 mm on each side of the fabric is fitted into Maxi Profiles, so 26 mm on each Fabric poster is not seen on the poster. Please arrange accordingly. Fabric is not included within the original pack. *13 mm von jeder Stoffseite wird in die Rahmennut der Maxi Profile gesteckt, somit werden insgesamt 26 mm des Posterstoffes nicht sichtbar sein. Stoffmass entsprechend anlegen. Der Stoff ist in den Produktpaketen nicht inbegriffen.*

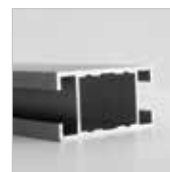
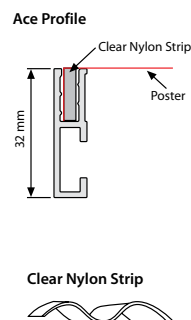
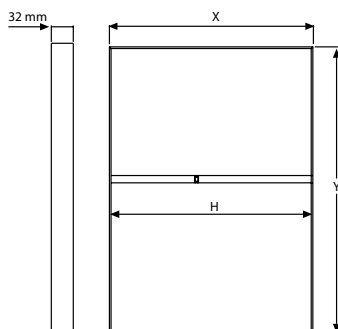

H profile / UYUP014106

MATERIAL : Silver anodised aluminium				WEIGHT	PACKING SIZE
ARTICLE	EXTERNAL (x-y)	H (mm)	H (Pcs)	WITH PACKING	*W X H X D
UMFB0000A4	210 X 297 mm	-	-	0,560 kg	60 X 350 X 50 mm
UMFB0000A3	297 X 420 mm	-	-	0,710 kg	60 X 470 X 50 mm
UMFB0000A2	420 X 594 mm	-	-	0,900 kg	60 X 650 X 50 mm
UMFB0000A1	594 X 841 mm	-	-	1,230 kg	60 X 890 X 50 mm
UMFB0000A0	841 X 1189 mm	-	-	1,690 kg	60 X 1240 X 50 mm
UMFB0000B2	500 X 700 mm	-	-	1,030 kg	60 X 750 X 50 mm
UMFB0000B1	700 X 1000 mm	-	-	1,430 kg	60 X 1120 X 50 mm
UMFB0000B0	1000 X 1400 mm	983 mm	1	2,480 kg	60 X 1500 X 50 mm
UMFB000510	500 X 1000 mm	-	-	1,210 kg	60 X 1120 X 50 mm
UMFB001010	1000 X 1000 mm	-	-	1,530 kg	60 X 1050 X 50 mm
UMFB001015	1000 X 1500 mm	983 mm	1	2,800 kg	60 X 1550 X 50 mm
UMFB001020	1000 X 2000 mm	983 mm	1	3,100 kg	60 X 2050 X 50 mm

* W:Width H: Height D: Depth



Gulf Maxi Single Sided

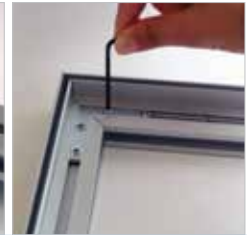
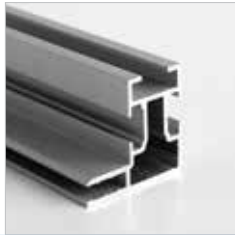

Dame Profile / 34x32 mm Gulf Maxi Frame

The single-sided MAXI FRAMES that are made up of Dame Profile are named GULF MAXI FRAMES.

Dame Profil / 34x32 mm Gulf Maxi Frame

Die aus Dame-Profil bestehenden, einseitigen Rahmen werden GULF MAXIFRAMES genannt.



Hang by using the assembling holes. The profile edges have corner cleats and are connected by allen key. For larger sizes of Gulf Maxi Frame, H-Profile is included in the pack with the quantities shown in the table.
 Aufhängung durch die Verbindungslöcher. Die Profilenden sind mit Eckschlössern versehen die mit dem Imbusschlüssel miteinander verbunden werden können. Für grössere Grössen des Gulf Maxi Rahmens werden Quertraversen den Produkten beigelegt. Anzahl der Quertraversen können Sie u.g Tabelle entnehmen.



The thickness of the profile is 4 mm. Supplied nylon strip is 3 mm, so recommended fabric thickness for digital printing is 0,5 mm. The pull sticker in 0,5 mm thickness must be sewed on the fabric for taking out the poster when fitted into the channels.
 Die Kanalbreite ist 4 mm. Die Silikonkeder ist 3 mm dick, somit wird als Textilgrafik für den Digitaldruck 0,5 mm dicker Stoff empfohlen. Die transparente Lasche ist 0,5 mm dick und muss an eine Seite des Stoffes genaht werden, um das Herausziehen der Grafik zu ermöglichen.



13 mm on each side of the fabric is fitted into Maxi Profiles, so 26 mm on each Fabric Poster is not seen on the poster. Please arrange accordingly. Fabric is not included within the original pack.
 13 mm von jeder Stoffseite wird in die Rahmennut der Maxi Profile gesteckt, somit werden insgesamt 26 mm des Posterstoffes nicht sichtbar sein. Stoffmass entsprechend anlegen. Der Stoff ist in den Produktpaketen nicht inbegriffen.

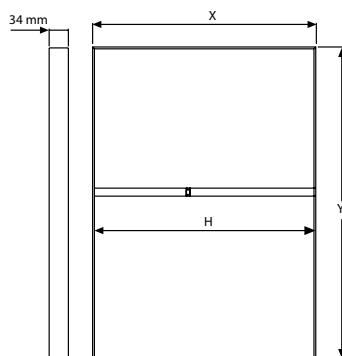
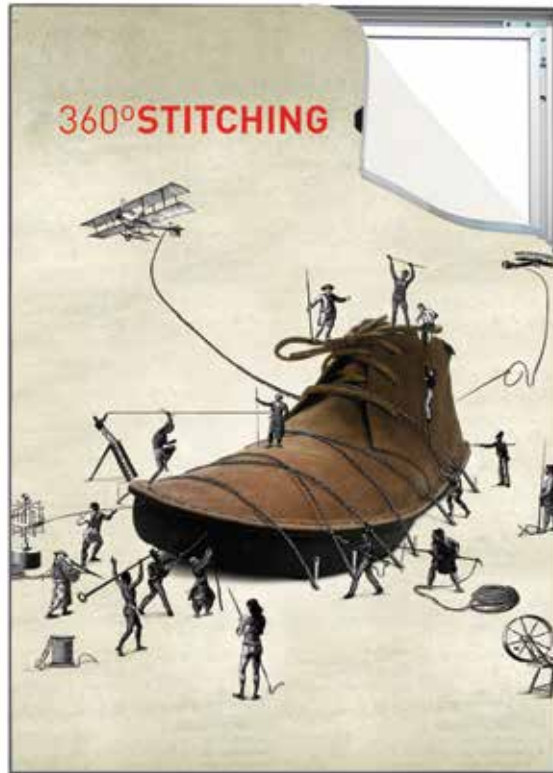

Dame Profile

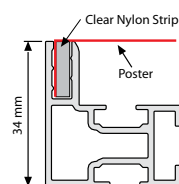

Clear Nylon Strip

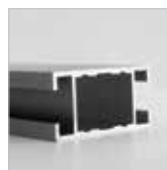

H profile / UYUP014106

MATERIAL : Silver anodised aluminium				WEIGHT	PACKING SIZE
ARTICLE	EXTERNAL (x-y)	H (mm)	H (Pcs)	WITH PACKING	*W X H X D
UMFG001020	1000 X 2000 mm	-	-	5,650 kg	70 X 208 X 115 mm
UMFG001030	1000 X 3000 mm	936 mm	1	7,820 kg	70 X 308 X 140 mm
UMFG001520	1500 X 2000 mm	-	-	6,600 kg	70 X 208 X 115 mm
UMFG001530	1500 X 3000 mm	1436 mm	1	8,970 kg	70 X 308 X 140 mm
UMFG002020	2000 X 2000 mm	-	-	7,450 kg	70 X 208 X 115 mm
UMFG002030	2000 X 3000 mm	1936 mm	2	11,180 kg	70 X 308 X 140 mm

* W:Width H: Height D: Depth



Lagoon Maxi Double Sided



Queen Profile / 45x15 mm Lagoon Maxi Frame
Used for ceiling hanging. The double-sided MAXI FRAMES that are made up of Queen Profile are named LAGOON MAXI FRAMES.

Queen-Profil / 45x15 mm Lagoon Maxi Frame
Die aus Queen-Profil bestehenden, doppelseitigen Rahmen werden LAGOON MAXIFRAMES genannt.

Suitable to hang from the ceiling. The profiles are connected to each other by the help of Square Corner Connector piece. For larger sizes of Lagoon Maxi Frame, H-Profile must be used. The special hanging pieces for fixing the ceiling with the wire cable, must be fixed into the top short side of the Lagoon Maxi Frame before the profiles are connected to each other.
Aufhängung durch Drahtseile. Die Profile werden mit Eckverbindern miteinander verbunden. Für grössere Grössen des Lagoon Maxi Rahmens müssen Quertraversen den Produkten beigefügt werden. Anzahl der Quertraversen können Sie u.g Tabelle entnehmen. Die Aufhänger für das Drahtseil müssen in das obere Profil eingesetzt werden, bevor die Profile miteinander verbunden werden.

The thickness of the profile is 4mm. Supplied nylon strip is 3 mm, so recommended fabric thickness for digital printing is 0,5 mm. The pull sticker in 0,5 mm thickness must be sewed on the fabric for taking out the poster when fitted into the channels.
Die Kanalbreite ist 4 mm. Die Silikonkeder ist 3 mm dick, somit wird als Textilgrafik für den Digitaldruck 0,5 mm dicker Stoff empfohlen. Die transparente Lasche ist 0,5 mm dick und muss an eine Seite des Stoffes genäht werden, um das Herausziehen der Grafik zu ermöglichen.

13 mm on each side of the fabric is fitted into Maxi Profiles, so 26 mm on each Fabric Poster is not seen on the poster. Please arrange accordingly. Fabric is not included within the original pack. Ceiling hangers are included in the original pack.
13 mm on each side of the fabric is fitted into Maxi Profiles, so 26 mm on each Fabric Poster is not seen on the poster. Please arrange accordingly. Fabric is not included within the original pack. The ceiling hangers are included in the original pack.



Hanging kit / UYUP460245

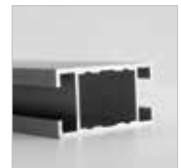

H profile / UYUP014106

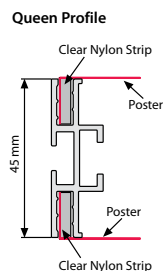
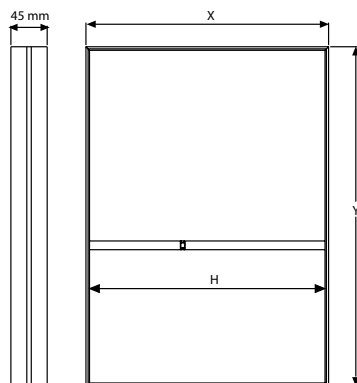

MATERIAL : Silver anodised aluminium				WEIGHT	PACKING SIZE
ARTICLE	EXTERNAL (x-y)	H (mm)	H (Pcs)	WITH PACKING	*W X H X D
UMFLO000A4	210 X 297 mm	-	-	0,800 kg	85 X 350 X 75 mm
UMFLO000A3	297 X 420 mm	-	-	1,020 kg	85 X 470 X 75 mm
UMFLO000A2	420 X 594 mm	-	-	1,410 kg	85 X 650 X 75 mm
UMFLO000A1	594 X 841 mm	-	-	2,070 kg	85 X 890 X 75 mm
UMFLO000A0	841 X 1189 mm	-	-	2,720 kg	85 X 1240 X 75 mm
UMFLO000B2	500 X 700 mm	-	-	1,690 kg	85 X 750 X 75 mm
UMFLO000B1	700 X 1000 mm	-	-	2,170 kg	85 X 1080 X 75 mm
UMFLO000B0	1000 X 1400 mm	970 mm	1	3,800 kg	110 X 1450 X 75 mm
UMFLO00510	500 X 1000 mm	-	-	2,070 kg	85 X 1080 X 75 mm
UMFLO01010	1000 X 1000 mm	-	-	2,510 kg	85 X 1080 X 75 mm
UMFLO01015	1000 X 1500 mm	970 mm	1	3,710 kg	110 X 1550 X 75 mm
UMFLO01020	1000 X 2000 mm	970 mm	1	4,300 kg	110 X 2050 X 75 mm

* W:Width H: Height D: Depth



Ocean Maxi

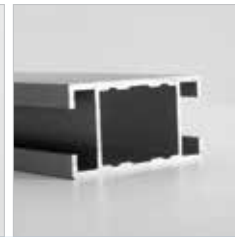
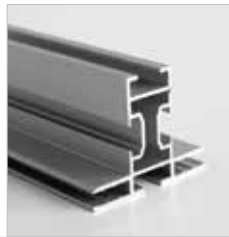

King Profile / 50x40 mm - Ocean Maxi Frame

Used with feet to be placed on a floor. The double-sided MAXI FRAMES that are made up of King Profile are named OCEAN MAXI FRAMES. Ocean Frame can be assembled with 4 different feet models. Before the assembly of the profile corners, the connector pieces for the feet need to be fitted into the profiles channels. Then, the feet are assembled over these connector pieces.

King-Profil / 50x40 mm - Ocean Maxi Frame

Wird mit den passenden Füßen auf dem Boden eingesetzt. Die doppelseitigen Maxi Frames aus dem King Profil werden Ocean Maxi Frames genannt. Wenn der Maxi Frame mit Füßen benutzt werden, können von 4 verschiedenen Fussalternativen ausgewaehlt werden. Die Verbindungsteile für die Füße müssen bevor die Ecken des Rahmens miteinander verbunden werden, in den Profilkanal eingeschoben werden. Danach können die Füße an die Verbindungsstücke montiert werden.

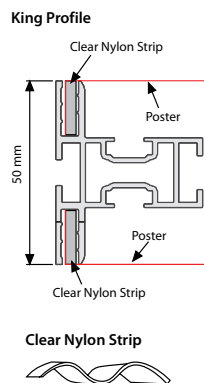
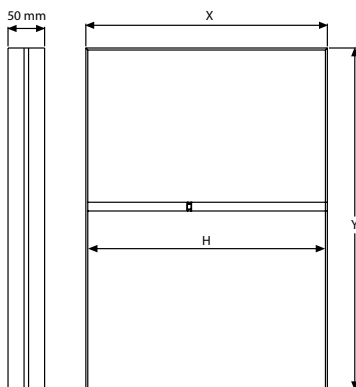
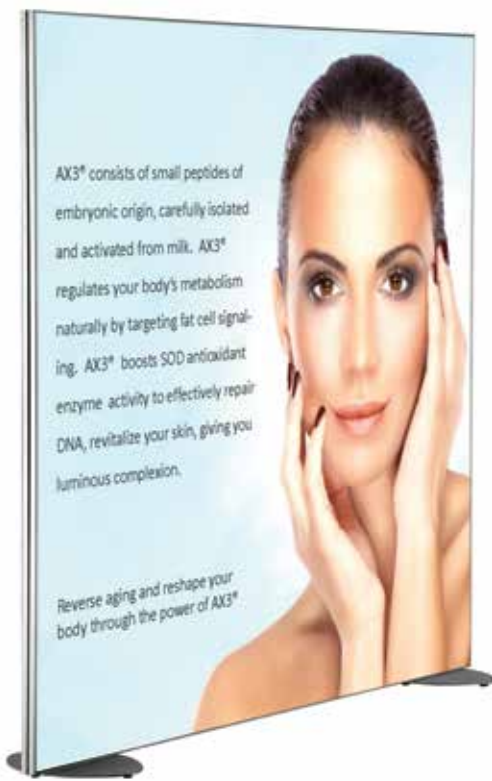

MATERIAL : Silver anodised aluminium				WEIGHT	PACKING SIZE
ARTICLE	EXTERNAL (x-y)	H (mm)	H (Pcs)	WITH PACKING	*W X H X D
UMF0001014	1000 X 1400 mm	-	-	5,050 kg	100 X 1450 X 140 mm
UMF0001015	1000 X 1500 mm	-	-	5,330 kg	100 X 1550 X 140 mm
UMF0001020	1000 X 2000 mm	-	-	6,160 kg	100 X 2080 X 140 mm
UMF0001022	1000 X 2250 mm	920 mm	1	7,340 kg	100 X 2280 X 140 mm
UMF0002015	2000 X 1500 mm	-	-	7,355 kg	100 X 2080 X 140 mm
UMF0002020	2000 X 2000 mm	-	-	8,100 kg	100 X 2080 X 140 mm
UMF0002022	2000 X 2250 mm	1920 mm	1	9,550 kg	100 X 2280 X 140 mm
UMF0003015	3000 X 1500 mm	1420 mm	1	10,220 kg	100 X 3080 X 140 mm
UMF0003020	3000 X 2000 mm	1920 mm	2	12,470 kg	100 X 3080 X 140 mm
UMF0003022	3000 X 2250 mm	2170 mm	2	13,040 kg	100 X 3080 X 140 mm

*W:Width H: Height D: Depth



Ocean Maxi



It can be used in 2 ways either by hanging to the ceiling or by fitting on 4 different designs of feet. The profiles edges have corner cleats and connected by allen key. For larger sizes of Ocean Maxi Frame, H-Profile must be used for stability. The special hanging pieces for fixing the ceiling with the wire cable, need be fixed into the top short side of the Ocean Maxi Frame before the profiles are connected to each other.

Der Artikel kann auf 2 verschiedenen Wegen zum Einsatz gebracht werden: Einmal durch die Drahtseilaufhängung oder indem eins der vier verschiedenen Fusslösungen eingesetzt wird. Die Profilenden sind mit Eckschlössern versehen die mit dem Imbusschlüssel miteinander verbunden werden können. Für grössere Grössen des Gulf Maxi Rahmens werden Quertraversen den Produkten beigefügt. Anzahl der Quertraversen können Sie u.g Tabelle entnehmen. Die Aufhänger für das Drahtseil müssen in das obere Profil eingesetzt werden, bevor die Profile miteinander verbunden werden.



The thickness of the profile is 4mm. Supplied nylon strip is 3 mm, so recommended fabric thickness for digital printing is 0,5 mm. The pull sticker in 0,5 mm thickness must be sewed on the fabric for taking out the poster when fitted into the channels.

(Die Kanalbreite ist 4 mm. Die Silikonkeder ist 3 mm dick, somit wird als Textilgrafik für den Digitaldruck 0,5 mm dicker Stoff empfohlen. Die transparente Lasche ist 0,5 mm dick und muss an eine Seite des Stoffes genaht werden, um das Herausziehen der Grafik zu ermöglichen.



13 mm on each side of the fabric is fitted into Maxi Profiles, so as overall 26 mm on each fabric poster is not seen on the poster. Please arrange accordingly. Fabric is not included within the original pack. Feet and ceiling hangers are not included in the original pack, please remember to place a separate order.

13 mm von jeder Stoffseite wird in die Rahmennut der Maxi Profile gesteckt, somit werden insgesamt 26 mm des Posterstoffes nicht sichtbar sein. Stoffmass entsprechend anlegen. Der Stoff ist in den Produktpaketen nicht inbegriffen.



Assembly of King Profile / Montage des King Profils



Assembly of H Profile / Montage der Quertraversen



BASEBALL FEET : RAL 9006 Powder coated. 6mm steel.

ARTICLE	SIZE	WEIGHT
UYUP412273	450 X 300 X 6 mm	4,700 kg



HOOP FEET: RAL 9006 Powder coated. 6mm steel.

ARTICLE	SIZE	WEIGHT
UYUP412272	Ø 450 X 6 mm	4,400 kg



CIRCLE FEET: RAL 9006 Powder coated. 6mm steel.

ARTICLE	SIZE	WEIGHT
UYUP412271	Ø 450 X 6 mm	7,500 kg



FILLET FEET : RAL 9006 Powder coated. 6mm steel.

ARTICLE	SIZE	WEIGHT
UYUP412274	500 X 180 X 6 mm	3,300 kg

Maxi Frame with LED



Dame Profile / 34x32 mm Maxi Frame with LED

Used with wall mounting fixture on the back. The unit is single sided & edge-lit. Pre-treated light guided panel diffuses light even & powerful. Offers evenly diffused lux in all sizes.

Dame Profil / 34x32 mm Maxi Frame with LED

Wird mit Aufhängern auf der Rückseite geliefert. Das Produkt ist einseitig und bis in die Ecken beleuchtet. Bearbeitetes Lichtpanel sorgt für kraftvolle und ebenmässige Lux Kraft in allen Grössen.



All units pass CE/UL Pat test and packed with quality certificates. 3,5 mt. electrical cable. UK and US plugs should be mentioned on order.
Alle Produkte sind CE/UL Pat getestet and werden mit Qualitätszertifikaten geliefert. 3,5 m Stromkabel. Falls UK und USA Stecker gewünscht ist die Angabe bei Bestellung erforderlich.



The thickness of the profile is 4mm. Supplied nylon strip is 3 mm, so recommended fabric thickness for digital printing is 0,5 mm. The pull sticker in 0,5 mm thickness must be sewed on the fabric for taking out the poster when fitted into the channels.
Die Kanalbreite ist 4 mm. Die Silikonkeder ist 3 mm dick, somit wird als Textilgrafik für den Digitaldruck 0,5 mm dicker Stoff empfohlen. Die transparente Lasche ist 0,5 mm dick und muss an eine Seite des Stoffes genaht werden, um das Herausziehen der Grafik zu ermöglichen.



13 mm on each side of the fabric is fitted into Maxi Profiles, so 26 mm on each Fabric Poster is not seen on the poster. Please arrange accordingly. Fabric is not included within the original pack.

13 mm von jeder Stoffseite wird in die Rahmennut der Maxi Profile gesteckt, somit werden insgesamt 26 mm des Posterstoffes nicht sichtbar sein. Stoffmass entsprechend anlegen. Der Stoff ist in den Produktpaketen nicht inbegriffen.

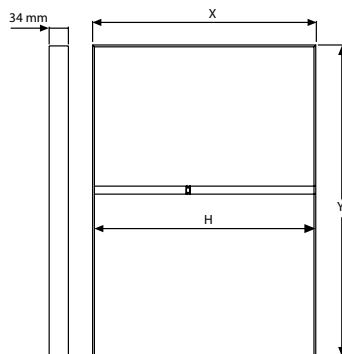

Dame Profile

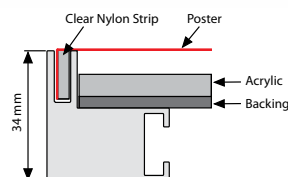

Clear Nylon Strip



MATERIAL : Silver anodised aluminium					WEIGHT	PACKING SIZE
ARTICLE	EXTERNAL (x-y)	H (mm)	H (Pcs)	LIGHTING	WITH PACKING	*W X H X D
UMLD3400A4	210 X 297 mm	-	-	2200-2400 LUX	1,450 kg	230 X 330 X 43 mm
UMLD3400A3	297 X 420 mm	-	-	2200-2400 LUX	2,250 kg	320 X 450 X 43 mm
UMLD3400A2	420 X 594 mm	-	-	2200-2400 LUX	3,800 kg	440 X 630 X 43 mm
UMLD3400A1	594 X 841 mm	-	-	2200-2400 LUX	7,350 kg	620 X 870 X 43 mm
UMLD3400A0	841 X 1189 mm	-	-	2000-2200 LUX	15,100 kg	870 X 1210 X 43 mm
UMLD3400B2	500 X 700 mm	-	-	2200-2400 LUX	5,010 kg	520 X 730 X 430 mm
UMLD3400B1	700 X 1000 mm	-	-	2000-2200 LUX	9,950 kg	720 X 1030 X 43 mm
UMLD3400B0	1000 X 1400 mm	936 mm	1	-	20,000 kg	1020 X 1430 X 43 mm
UMLD340023	508 X 762 mm	-	-	2200-2400 LUX	5,400 kg	530 X 800 X 43 mm
UMLD340034	762 X 1016 mm	-	-	2000-2200 LUX	10,650 kg	790 X 1050 X 43 mm
UMLD340046	1016 X 1524 mm	952 mm	1	-	23,500 kg	1040 X 1560 X 43 mm

* W:Width H: Height D: Depth



Semi Products for Maxi Frames



Profiles of Maxi Frames / Profile der Maxi Rahmen

Valet Profile

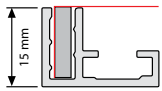

Article: UYUP014103
Single Sided MAXI profile
VALET Profile Suitable for
RIVER MAXI 15x22 mm,
3 meters.

Art.Nr: UYUP014103
Einseitiges VALET Profil
VALET Profil wird
verwendet für RIVER MAXI
15x22 mm, 3 Meter Länge.

Ace Profile

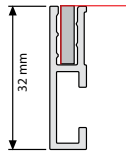

Article: UYUP014105
Single Sided MAXI profile
ACE Profile Suitable for
BAY MAXI 32x8 mm,
3 meters.

Art.Nr: UYUP014105
Einseitiges ACE Profil
ACE Profil wird verwendet für
BAY MAXI 32x8 mm,
3 Meter Länge.

Dame Profile

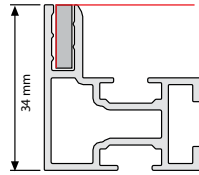

Article: UYUP014102
Single Sided MAXI profile
Dame Profile Suitable
for GULF MAXI and
ILLUMINATED MAXI
34x32 mm, 3 meters.

Art.Nr: UYUP014102
Einseitiges DAME Profil
DAME Profil wird
verwendet für GULF MAXI
und ILLUMINATED MAXI
34x32 mm, 3 Meter Länge.

Queen Profile

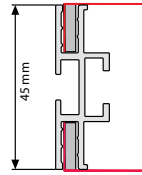

Article: UYUP014104
Double Sided MAXI
profile QUEEN Profile
Suitable for LAGOON
MAXI 45x15 mm,
3 meters.

Art.Nr: UYUP014104
Doppelseitiges QUEEN-
Profil QUEEN Profil wird
verwendet für LAGOON
MAXI 45x15 mm,
3 Meter Länge.

King Profile

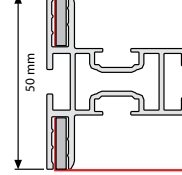

Article: UYUP014101
Double Sided MAXI profile
KING Profile Suitable for
OCEAN MAXI 50x40 mm,
3 meters.

Art.Nr: UYUP014101
Doppelseitiges
KING-Profil KING Profil wird
verwendet für OCEAN MAXI
50x40 mm, 3 Meter Länge.

H Profile

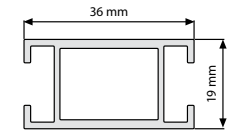

Article: UYUP014106
H Profile, 36 x19 mm,
3 meters. Suitable for Ace,
Dame, Queen and King
profiles.

Art.Nr: UYUP014106
H-Profil für Quertraversen
36x19 mm, 3 Meter Länge.
Geeignet für Ace, Dame,
Queen und King profile.

Components of Maxi Frames / Komponenten der Maxi Rahmen

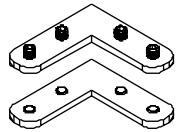

Article: UYUP412295
Corner Cleat for OCEAN & GULF
Packed by 8.

Art.Nr: UYUP412295
Spann-Schloß 45° wird verwendet
für OCEAN & GULF 8 Stk.

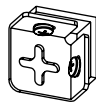

Article: UYUP412270
Square Corner Connector for
BAY & LAGOON Packed by 10.

Art.Nr: UYUP412270
Rahmenverbinder wird verwendet
für BAY & LAGOON 10 Stk.

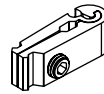

Article: UYUP412291
Straight Cleat for H profile Packed by 8.

Art.Nr: UYUP412291
Gerades Spann-Schloß für
Quertraverse. 8 Stk.

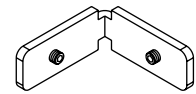

Article: UYUP412310
Straight Cleat for H profile
Packed by 8.

Art.Nr: UYUP41231
Gerades Spann-Schloß für
Quertraverse. 8 Stk.

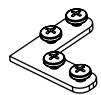

Article: UYUP025010
L TYPE Corner Connector for
RIVER Packed by 10.

Art.Nr: UYUP025010
Eckverbinder kompl. mit Schrauben
für RIVER VPE 0 10 Stk.

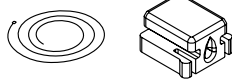

Article: UYUP460245
Hanging System including wire cable
for double sided MAXI. Packed by 8.

Art.Nr: UYUP460245
Drahtseil-Abhängung für doppelseitige
MAXI VPE 8 Stk.



Article: UYUP460235
Clear Nylon Strip
13 x 3 mm, 100 meters.

Art.Nr: UYUP460235
Silikon-Keder 13 x 3 mm 100 meter.



Article: UYUP460220
Clear Nylon Strip with tape
13 x 3 mm, 50 meters.

Art.Nr: UYUP460220
Silikon-Keder mit Klebeband
13 x 3 mm 50 meter.

Feets of Maxi Frame (To be used with Double Sided King Profile) / Fusslösungen für Maxi Rahmen (benutzbar mit dem doppelseitigem King Profil)

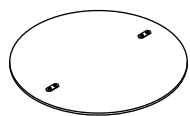

Article: UYUP412271
Circle Ø 450 x 6mm single packed.

Art.Nr: UYUP412271
Teller-Fuß 450x6 mm Einzel verpackt.

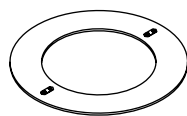

Article: UYUP412272
Hoop Ø 450 x 6mm single packed.

Art.Nr: UYUP412272
Kreis-Fuß 450x6 mm Einzel verpackt.

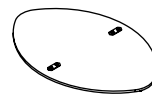

Article: UYUP412273
Baseball 450 x 300 x 6mm single packed.

Art.Nr: UYUP412273
Oval-Fuß 450 x 300 x 6mm Einzel verpackt.



Article: UYUP412274
Fillet 500 x 180 x 6mm single packed.

Art.Nr: UYUP412274
Design-Fuß 500 x 180 x 6mm Einzel verpackt.

Maxi Frames Rubber Strip



Nylon strip application when sew on textile

We launched the new Version 1.0 Maxi Frame rubber strip application existing in Maxi Frame Index. Through this specification development process, we will both assess new opportunities for easy and fast product assembly and the potential to mount Maxi Frames free from sew-on process in exhibition areas and event places. We invite your participation in following the below information over the increased performance for rubber strips when combined with double sided tape.

Due to the potential expansion of Maxi Frame, which is a high quality frame system composed of stylish aluminum profiles to create a 'frameless' look, in various applications and custom printed

polyester fabric, there have been many requests for easy and sewing-free application of printing inward the profiles.

We redesigned the existing product focusing to purchase, and use of efficient components. For this purpose we concentrated on addition of double sided tape over existing rubber strip.

We defined the types of equipment to cover the new production process of rubber with correct tape and determined the appropriate means of testing the application in tension of various types and thicknesses.

We prepared the below assembly sheet and movie to better express the application and improvement over the taped rubber strip.

NEW Application with double sided tape.



Application of nylon strip by sew-on process



Application of nylon strip by double sided tape





The sky is the limit
with our range of
outdoor banners!

OMNIFRAME

www.omni-frame.com

OHIM DM/084 725

Suitable for outdoor large format prints, Omni Frame is a large format Outdoor Banner System, made from lightweight aluminium. It is ideal for use with PVC eyelet banners. Omni Frame Banner System is used for large advertising areas which need to be changed regularly such as most forecourts and retail environments. It is also a great accompaniment for marquees and race events. Omni Frame is suitable for flat, large banners on buildings as well as mounting stand displays for indoor and outdoor use. The variable lengths of aluminium profile give you the ability to install banners in customised size. This banner holder is assembled quickly and easily, it is a real alternative to traditional billboards. These outdoor durable frames are permanently attached to the wall with the banner using elasticated straps. These are perfect displays for forthcoming events, special offers or sales, theatres, garden centres, retail outlets, sports halls, sporting venues, conferences, airports and public areas. Omni Frame has a smart design and all parts are robust, durable and reusable. The banner is easy to change. Customised sizes are available upon request. It is delivered parts unassembled to save from transport.

FEA TEST RESULTS OF OMNI FRAME

Omni Frame is tested for security in outdoor conditions. Conditions: Without any back rest, Omni Frame is tested against windy conditions max 22,5 miles or 36km. Vinyl banner deforms and may not take previous form again based on the type and quality of material. In case of 2-fold eyelet application, the banner keeps the form upto wind speed of 22miles. Test had been conducted with 5m x 10m Omni Frame with 1mm vinyl banner.

Result: Omni Frame is strong and stable for harsh weather conditions. Banner may get damaged depending on the banner and application. MT Displays recommends the apply eyelets 2-fold vinyl banner for harsh weather conditions.

Der Omni Frame ist ein Produkt für große Werbelösungen im Außenbereich. Hergestellt wird dieser aus einem leichten Aluminium. Perfekt geeignet für die Verwendung für PVC Poster mit Ösen. Das Omni Frame System wird für große Werbeflächen verwendet und erleichtert den Bannerwechsel welcher häufig geändert werden muss im Einzelhandel oder an Parkplätzen. Dieser ist auch ein großartiger Begleiter für Events und Rennveranstaltungen. Der Omni Frame eignet sich für flache, große Banner am Gebäude sowie auch am Montageständer im Innen – und Außenbereich. Durch die variablen Längen der Profile, erhalten Sie die Möglichkeit auch kundenspezifische Größen anzubieten. Dieser Banner Halter ist schnell und einfach montiert und bietet zudem eine echte Alternative zu traditionellen Werbetafeln. Die haltbaren Rahmen sind dauerhaft an die Wand montiert und halten das Banner mit elastischen Gummis. Somit auch ideal geeignet für Sonderangebote oder Verkäufe, Theater, Garten-Center, Einzelhandelsgeschäfte, Sporthallen, Sportstätten, Konferenzen, Flughäfen und öffentlichen Bereichen. Der Omni Frame ist sehr einfach gestaltet und alle Teile sind robust, langlebig und wiederverwendbar. Das Poster ist sehr leicht zu wechseln. Sondergrößen sind auf Anfrage erhältlich. Die Produkte werden aus transporttechnischen Gründen demontiert geliefert.

FEA TESTERGEBNISSE DER OMNI FRAME

Der Omni Frame wurde auf Sicherheit bei Einsatz im Außenbereich getestet. Bedingungen: Ohne Rückenstütze wurde das Produkt auf eine Windstärke von 22,5 Meilen oder 36 km/h getestet. Das Vinyl wird deformiert und wird die Ursprungsform nicht mehr annehmen können, basierend natürlich je nach Material und Qualität. Im Falle einer 2 Ösen Applikation, behält das Vinyl die Form bis zu einer Windgeschwindigkeit von 22 Meilen/h oder 35km/h. Der Test wurde mit den Produktmaßen von 5m x 10m Omni Frame und einem 1mm Vinyl ausgeführt.

Resultat: *Der Omni Frame ist stabil unter strengen Wetterkonditionen. Das Vinyl wird wahrscheinlich beschädigt je nach Vinyl und Applikation. MT Displays empfiehlt die Anwendung der 2 Ösen Applikation unter rauen Wetterbedingungen.*



Omni Frame



www.omni-frame.com



Fabric is the best recommended option for outdoor advertising. It shines with its light weight and durability among other alternatives such as PVC, Vinyl & Polyethylene. The advantages also include ease of application and compatibility with its stand. The plastic buttons are easily inserted into the channel on Omni Frame profiles. For renewal of the banner, the frame does not have to be unmounted. Poster can only be replaced by taking of the elastic hook.

Stoff ist die Beste empfohlene Option für die Außenwerbung. Dieser glänzt mit seinem geringen Gewicht und der Haltbarkeit gegenüber anderen Alternativen wie zB. PVC, Vinyl und Polyethylen. Die Vorteile sind: einfache Anwendung und die Kompatibilität in der Ausführung. Die Plastikhalterungen sind sehr einfach in den Kanal auf der Rückseite des Profils einzusetzen. Zum Auswechseln des Posters, muss der Rahmen nicht von der Wand abmontiert werden. Das Poster kann mit dem heraus nehmen der elastischen Haken ausgewechselt werden.

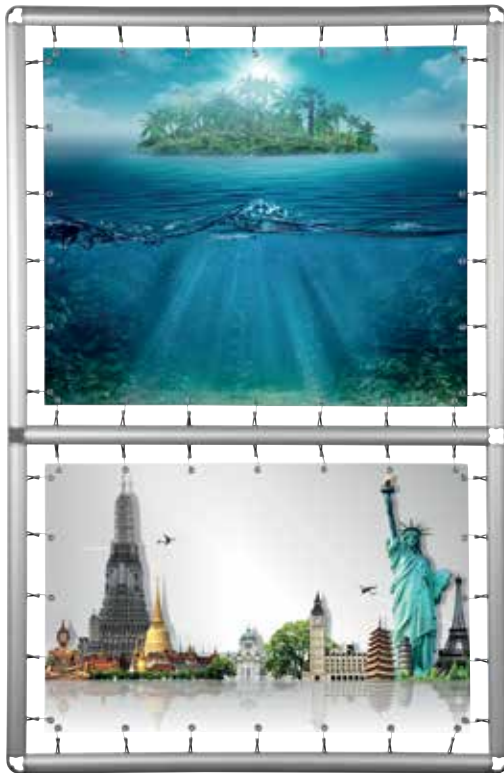

OHIM DM/084 725

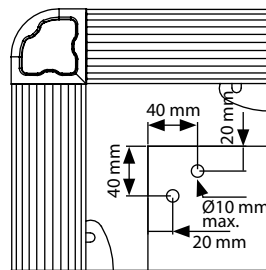
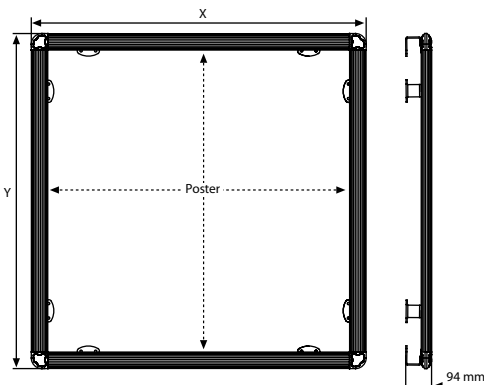

The first eyelet should be placed on the corners 40 mm from the edges of poster used for Omni Frame. Please see below basic drawing. The other eyelets can be applied spacing 15-30 cm from the first eyelet depending on the environment to be used.

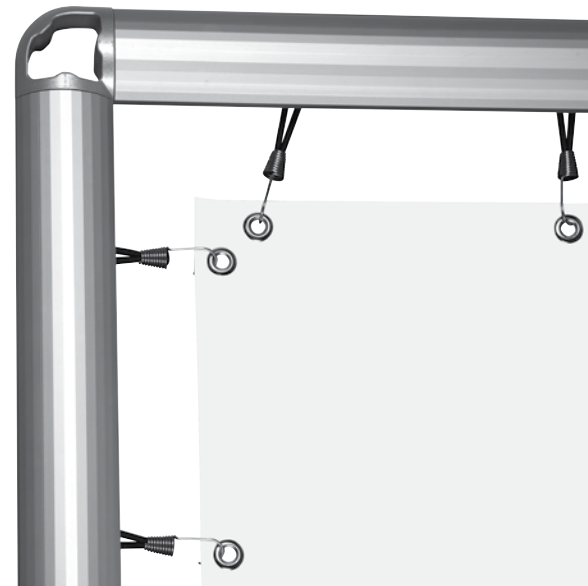

Omni Frame



www.omni-frame.com

4 different application options

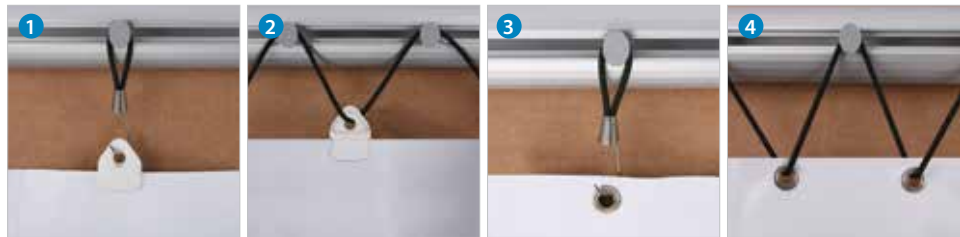

Omni Frame is a flexible outdoor display system with excellent durability to make combinations via several units for greater visual impact. Limited number of parts, offers solutions for any size request.

Der Omni Rahmen ist ein flexibles und ausgezeichnetes Haltbares Außendisplay um auch verschiedene Einheiten für größere Visualisierungen miteinander zu kombinieren. Eine limitierte Anzahl von Teilen bieten eine Lösung für Anfragen jeder Größe.

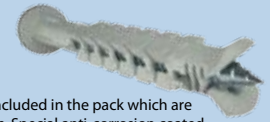

Wall fixing screws of Omni Frame are included in the pack which are CE certified multi-expansion long plugs. Special anti-corrosion coated screw is made of zinc coated steel and plastic sleeve made of high quality of nylon. It is confirmed for outdoor fixing on various exterior building surfaces such as concrete, solid or honeycomb brick, hollow dense or hollow light aggregate block, aerated concrete and solid stone.

Das Wandmontage Zubehör des Omni Frame ist im Lieferumfang enthalten welche auch CE zertifiziert sind. Spezielle anti-korrosion beschichteten Schrauben sind hergestellt aus Zink und einer Plastikhülle aus hoher Nylonqualität. Geeignet und bestätigt für den Gebrauch an diversen Aussenfassaden wie Beton, Solid oder Wabenziegeln, dichten Hohl oder leichten Hohl Block, belüfteten Beton oder solidem Stein.



UYPOM02000
Corner bracket
(Packed by 4 pcs), Ral 9006



UYPOM03000
T Connector
(Packed by 2 pcs), Ral 9006



UYPOM06000
Profile connector
(Packed by 2 pcs), Ral 9006



UYPOM04000
Wall fixing
(Packed by 4 pcs),
including screw set.



UYPOM05000
Plastic buttons
(Packed by 20 pcs)



TMC4010S00
Clamp for banner,
White (Packed by 40 pcs)



TSH4010S01
Black bungee cord with
stainless steel hook
(Packed by 40 pcs)



UYPOM07000
Elastic strap (50 meters)



Aluminium profile, silver
anodised.

Presentation Box / UYPOM00010



OMNI FRAME PROFILE		WEIGHT	PACKING SIZE
ARTICLE	LENGHT	WITH PACKING	*W X H X D
UYPOM01011	1100 mm	1,300 kg	55 X 1150 X 75 mm
UYPOM01016	1600 mm	1,800 kg	55 X 1650 X 75 mm
UYPOM01021	2100 mm	2,300 kg	55 X 2150 X 75 mm
UYPOM01026	2600 mm	2,800 kg	55 X 2630 X 75 mm
UYPOM01031	3100 mm	3,300 kg	85 X 1730 X 115 mm
UYPOM01036	3600 mm	4,000 kg	85 X 1970 X 115 mm
UYPOM01041	4100 mm	4,350 kg	85 X 2220 X 115 mm
UYPOM01046	4600 mm	5,000 kg	85 X 2470 X 115 mm
UYPOM01051	5100 mm	4,000 kg	85 X 2720 X 115 mm

OMNI FRAME: Silver anodised aluminium			WEIGHT	PACKING SIZE
ARTICLE	EXTERNAL (x-y)	POSTER SIZE	WITH PACKING	*W X H X D
UOMN001010	1221 X 1221 mm	1000 X 1000 mm	7,395 kg	215 X 1750 X 105 mm
UOMN001015	1221 X 1721 mm	1000 X 1500 mm	8,965 kg	215 X 2100 X 105 mm
UOMN001515	1721 X 1721 mm	1500 X 1500 mm	10,175 kg	215 X 2300 X 105 mm
UOMN001520	1721 X 2221 mm	1500 X 2000 mm	11,610 kg	215 X 2600 X 105 mm

OMNI FRAME SEMI PRODUCTS		WEIGHT	PACKING SIZE
ARTICLE	DESCRIPTION	WITH PACKING	*W X H X D
UYPOM02000	Corner Bracket (Packed by 4 pcs), Ral 9006	1,800 kg	95 X 240 X 165 mm
UYPOM03000	T Connector (Packed by 2 pcs), Ral 9006	0,900 kg	95 X 240 X 165 mm
UYPOM04000	Wall Fixing (Packed by 4 pcs), including screw set	2,000 kg	95 X 150 X 100 mm
UYPOM05000	Plastic Buttons (Packed by 20 pcs)	0,020 kg	
UYPOM06000	Profile Connector (Packed by 2 pcs), Ral 9006	0,400 kg	85 X 270 X 90 mm
TMC4010S00	Clamp For Banner, White (Packed by 40 pcs)	0,520 kg	
TSH4010S01	Black Bungee Cord with Stainless Steel Hook (Packed by 40 pcs)	0,420 kg	
UYPOM07000	Elastic Strap (50 meters)	0,100 kg	

*W:Width H: Height D: Depth



Insert and fix with screw.



Corner bracket made of aluminium injection metallic silver powder coated.

Insert banner buttons into the rear channel of the profile.



Omni A Board



www.omni-frame.com



Constructed aluminium, Omni A Board is a double sided, heavy outdoor banner system. It is ideal for use with PVC eyelet banners. Omni A Board is used for large advertising areas that the banner needs to be changed regularly or carried to different places. It is a great accompaniment for outdoor events, marquees and race. Omni Frame withstands approximately 42-50kph wind.

Gefertigt aus Aluminium und in einer doppelseitigen Ausführung ist der Omni A board ein sehr stabiles schweres Bannerprodukt für den Außeneinsatz. Es ist ideal für die Verwendung mit PVC Ösenposter. Eingesetzt bei großen Werbeflächen und wenn man das Poster regelmäßig wechseln oder das Produkt an verschiedenen Orten positionieren möchte. Ein großer Begleiter für Outdoor-Events, Festzelte und Rennveranstaltungen. Omni Frame hält einer Windgeschwindigkeit von 40-50km/h stand.

Shipped unassembled. Demontiert geliefert.

Banner and eyelets not included. Poster und Ösen nicht inkludiert.

Plastic buttons and elastic hooks included enough for each size. Plastikhalter und elastische Haken genügend inkludiert.

2 packs. See info chart for pack sizes. 2 Packungen. Siehe Infodiagramm für Packungsgrößen.

Perfect outdoor use.

- Ease of transport, quick&easy installation.
- Flexible outdoor display with excellent durability.



Carry bag

OHIM DM/084 725

1,2 kg Each feet.

BAG: Black	
ARTICLE	SIZE
UYPOM00010	265 X 2650 X 205 mm
UYPOM00020	265 X 1630 X 205 mm

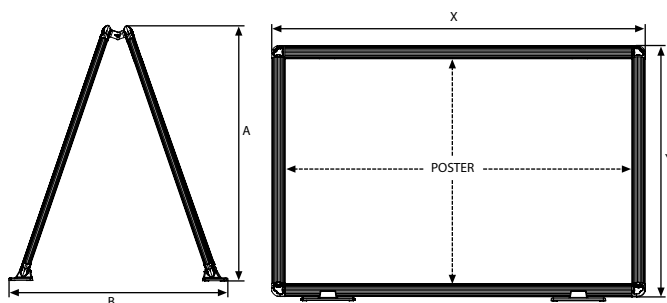

OMNI A BOARD FEET / HINGE

ARTICLE	DESCRIPTION
UYPOM09000	Feet for Omni Aboard, 4pcs per pack
UYPOM10000	Hinge for Omni Aboard, 2pcs per pack

OMNI FRAME: Silver anodised aluminium					WEIGHT	PACKING SIZE
ARTICLE	EXTERNAL (x-y)	POSTER SIZE	A	B	WITH PACKING	*W X H X D
UAOMN01510	1221 X 1721 mm	1000 X 1500 mm	1177 mm	986 mm	19,500 kg	265 X 1640 X 90 mm / 340 X 490 X 135 mm
UAOMN02510	1221 X 2721 mm	1000 X 2500 mm	1177 mm	986 mm	24,000 kg	275 X 2650 X 90 mm / 340 X 490 X 135 mm
UAOMN03012	1471 X 3221 mm	1250 X 3000 mm	1413 mm	1150 mm	28,500 kg	275 X 1600 X 145 mm / 340 X 500 X 195 mm

*W:Width H: Height D: Depth

