



Counter Displays

- Panset Counters
- Pop-up Counter
- Promostand
- Petite Promostand
- Rectangular Promostand
- Circle Promostand
- Bean Promostand
- Seed Promostand

- Falt-Theke
- Pop-up Counter
- Promotiontheke
- Petite Promostand
- Rectangular Promostand
- Circle Promostand
- Bean Promostand
- Seed Promostand



Panset Hexagonal Counter



Panset counters are ideal products with a light & compact structure. They can be carried to different locations and re-used many times. It is easy and quick to install. Different models meet your needs in the most convenient manner. These counters are lightweight and fit quickly in the corner of a car.

Die falt-Theken bieten ideale Lösungen für vielseitige Verwendungen an, da sie sehr leicht und kompakt sind. Mit ihrer Eigenschaft der schnellen Zusammenstellung ermöglichen sie dem Verwender eine leichte Handhabung. Je nach Ihrem Bedarf stehen verschiedene Ausführungen zur Auswahl.



After the panels are assembled, due to the fitting of panels inside the construction, the visual area is 0,5 cm smaller on all sides.
Bitte berücksichtigen Sie bei der Gestaltung, daß jeweils 0,5 cm auf jeder Seite des Grafikpanels durch die profile verdeckt werden.



Please first fix the shelf and then the top plate. Black textile carry bag is optional.
Befestigen Sie zunächst den Zwischenboden und danach die obere Tischplatte. Schwarze Transporttasche ist extra zu bestellen.



Max. carriage capacity 25 kg.

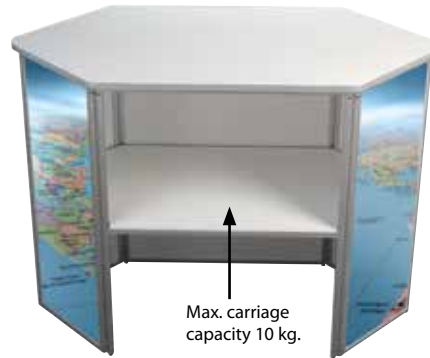

Max. carriage capacity 10 kg.



Transport bag / UYUP074100

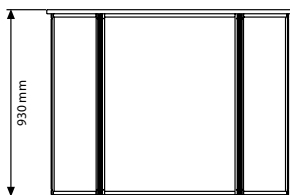
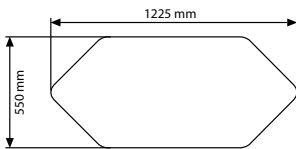

MATERIAL : Silver anodised aluminium PANEL : Plastech PVC Foam				WEIGHT	PACKING SIZE
ARTICLE	MODEL	PANEL	QUANTITY	WITH PACKING	*W X H X D
UPSM001000	Hexagonal	878 X 659 mm	1	19,300 kg	720 X 1270 X 130 mm
		878 X 311 mm	4		
UPSM007000	Wood Hexagonal	878 X 659 mm	1	21,300 kg	720 X 1270 X 130 mm
		878 X 311 mm	4		



*W:Width H: Height D: Depth

Panset Convex Counter



Panset counters are ideal products of light & compact structure, they can be carried to different locations and re-used many times. It is easy and fast in assembly. Different models offer you the most convenient choice for your needs. These lightweight counters fit quickly in the corner of a car.

Die Fallthecken bieten ideale Lösungen für vielseitige Verwendungen an. Da diese sehr leicht und kompakt sind, ermöglichen Sie die Nutzung an verschiedenen Plätzen über mehrere Male. Schneller und leichter Aufbau. Die passende Ausführung nach Ihrem Bedarf kann aus unserem Sortiment ausgewählt werden. Klein und handlich passt er in jede Autoecke.



After the panels are assembled, due to the fitting of panels inside the construction, the visual area is 0,5 cm smaller on all sides. Bitte berücksichtigen Sie bei der Gestaltung, daß jeweils 0,5 cm auf jeder Seite des Grafikpanels durch die profile verdeckt werden.



Please first fix the shelf and then the top plate. Black textile carry bag is optional. Befestigen Sie zunächst den Zwischenboden und danach die obere Tischplatte. Schwarze Transporttasche ist extra zu bestellen.



Max. carriage capacity 15 kg.



Max. carriage capacity 20 kg.

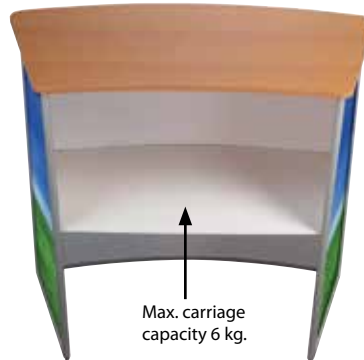

Max. carriage capacity 6 kg.



Transport bag / UYUP074000

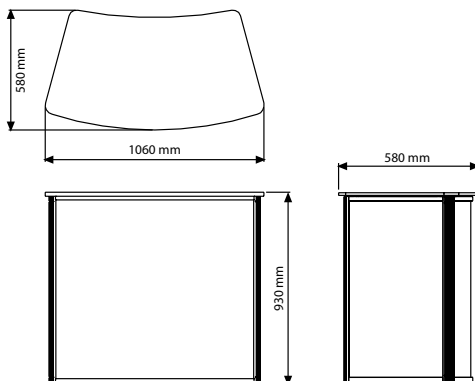

MATERIAL : Silver anodised aluminium PANEL: Plastech PVC Foam				WEIGHT	PACKING SIZE
ARTICLE	MODEL	PANEL	QUANTITY	WITH PACKING	*W X H X D
UPSM002000	Convex	878 X 980 mm	1	20,100 kg	950 X 1180 X 140 mm
		878 X 430 mm	2		
UPSM008000	Wood Convex	878 X 980 mm	1	20,150 kg	950 X 1180 X 140 mm
		878 X 430 mm	2		



*W:Width H: Height D: Depth

Midsize Convex Counter



Midsize Convex Table is developed as a low-cost carry-away counter for temporary events and mobile needs. It's an ideal light desk that can be re-used many times and quick to install. Midsize Convex counters can be used as demo stations or product displays.

Die mittelgrosse Konvextheke wurde als kostengünstige Thekenversion für Veranstaltungen und mobile Bedürfnisse entwickelt. Ausserordentlich leicht gewichtig und kann über mehrere Male wieder verwendet werden. Leichter Aufbau. Mittelgrosse Konvextheken können zu Produktpräsentationen oder Produktdemonstrationen eingesetzt werden.



After the panels are assembled, due to the fitting of panels inside the construction, the visual area is 0,5 cm smaller on all sides.

Bitte berücksichtigen Sie bei der Gestaltung, dass jeweils 0,5 mm auf jeder Seite der Grafikpaneele von den Profilen verdeckt werden.



Please first fix the shelf and then the top plate. Black textile carry bag is optional.

Befestigen Sie zunächst den Zwischenboden und danach die obere Tischplatte. Schwabe Transporttasche ist extra zu bestellen.



Max. carriage capacity 15 kg.

Max. carriage capacity 6kg.



Transport bag / UYUP070200

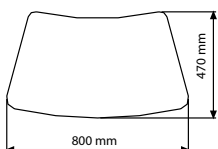

470 mm

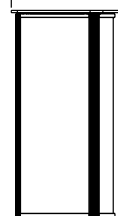
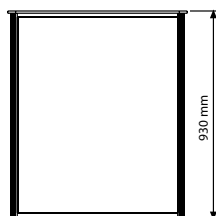

MATERIAL : Silver anodised aluminium PANEL: Plastech PVC Foam			WEIGHT	PACKING SIZE
ARTICLE	PANEL	QUANTITY	WITH PACKING	*W X H X D
UPSMOS2000	718 X 878 mm	1	18,100 kg	950 X 1180 X 140 mm
	335 X 878 mm	2		



* W:Width H: Height D: Depth

Pop-up Counter



The pop-up counter offers an easy low-budget solution that can be carried to various locations and even re-used after many events. The counter can pop up in a second with no tools required.

Die Pop-up Theke bietet kostengünstige Lösungen, kann mobil an mehreren Veranstaltungen eingesetzt werden. Die Theke ist in Sekunden einsatzbereit ohne Werkzeugbedürfnisse einsatzbereit.



When we put the panel on the bag, the panel ends will overlap each other by 20 mm. Bitte berücksichtigen Sie bei der Gestaltung, dass sich auf der Rückseite in der Mitte 20 mm des Grafikpanels überlappen werden.



Max. carriage capacity 30 kg.

Black top plate

Wood top plate

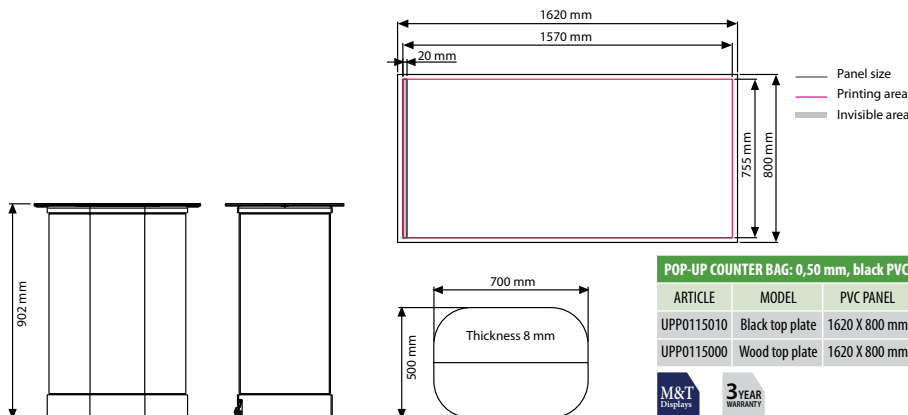

POP-UP COUNTER BAG: 0,50 mm, black PVC panel						WEIGHT	PACKING SIZE
ARTICLE	MODEL	PVC PANEL	COPY SIZE	TOP PLATE	MAGNETIC BAR	WITH PACKING	*W X H X D
UPP0115010	Black top plate	1620 X 800 mm	1550 X 755 mm	700 X 500 mm	1 Pcs	13,810 kg	420 X 920 X 600 mm
UPP0115000	Wood top plate	1620 X 800 mm	1550 X 755 mm	700 X 500 mm	1 Pcs	13,810 kg	420 X 920 X 600 mm

*W:Width H: Height D: Depth



Promostand



This simple counter is suitable for exhibitions, demonstrations and other kinds of presentation. Produced in white plastic material, ready for any kind of decoration. Foldable and easy to transport and mount. Delivered with or without carry bag. We use powder coated steel pipes to hold 3 mm thick header panel made of Plastech PVC foam.

Diese einfache Theke ist geeignet für Ausstellungen, Vorführungen und verschiedene Arten von Präsentationen. Sie besteht aus weißem Kunststoff und passt zu jeder Dekoration. Leicht faltbar, leicht zu transportieren und leicht aufzubauen. Geliefert wird das Produkt auf Wunsch auch mit Transporttasche. Pulverbeschichtete Stahlrohre halten das 3 mm starke Topschild, aus Plastech PVC Schaumplatte.



Product is packed unassembled with an easy-to-understand instruction sheet. Das Produkt wird demontiert mit einer Montageanleitung geliefert.



After the front panel is assembled due to fitting of panels inside the plastic construction, the visual area is 38 mm smaller on top & bottom ends. Thickness of front panel is 3 mm. Thickness of counter & shelves is 3 mm. Nach Anbringung der Werbeflächen an die Panele werden, wegen der Befestigungen sowohl oben als auch unten 38 mm an Sichtfläche verloren gehen. Stärke des vorderen Panels ist 3 mm, Stärke der Abdeckplatte und der Zwischenablage ist 3 mm. Montage ohne Werkzeug.



3 mm PP solid front panel



3 mm Plastech PVC Foam

Strong & elegant powder coated steel pipes

•3 mm PS firm top plate
•Max. carriage capacity 25 kg.

Aluminium bar

Max. carriage capacity 20 kg.



Transport bag / UYUP072200

Printing Size

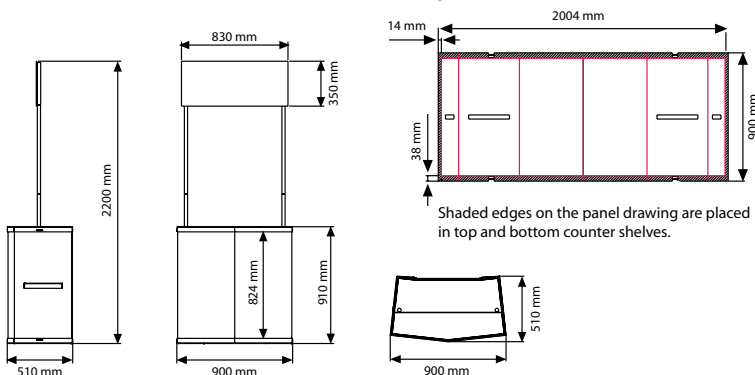

MATERIAL : Plastic				WEIGHT	PACKING SIZE
ARTICLE	DESCRIPTION	PANEL SIZE	COPY SIZE	WITH PACKING	*W X H X D
UTSO0N5000	Without bag	2004 X 900 mm	1992 X 824 mm	13,600 kg	550 X 950 X 160 mm
UTSO0N5100	With bag	2004 X 900 mm	1992 X 824 mm	14,100 kg	550 X 950 X 160 mm

*W:Width H:Height D:Depth



Petit Promostand



Petit Promostand is an outstanding counter for exhibition products demos and sample distribution. It is portable, lightweight and has white plastic material. Easy to assemble with no tools required. Front panel & top header offer space for poster printing and decoration. Designed as a foldable mobile unit, it quickly fits in the corner of a car.

Der kleine Promostand bietet Möglichkeiten der Produktpresentation und Produktverteilung auf Ausstellungen oder Einkaufszentren. Er besteht aus leicht gewichtigem weissem Plastikmaterial. In sekunden Schnelle ohne Werkzeug aufgebaut. Vorderpanel und Topschild bieten Platz für Poster und Dekoration. Er wurde als faltbare, mobile Theke entwickelt, der in jede Autoecke passt.



Product is packed unassembled with an easy-to understand instruction sheet. Das Produkt wird demontiert mit einer Montageanleitung geliefert.



After the front panel is assembled due to fitting of panels inside the plastic construction, the visual area is 38 mm smaller on top & bottom ends. Thickness of front panel is 2,5 mm. Thickness of counter & shelves is 2,5 mm. No tool assembly. Nach Anbringung der Werbefläche an die Panele werden wegen der Befestigungen sowohl oben als auch unten 38 mm an Sichtfläche verloren gehen. Stärke des vorderen Panels ist 2,5 mm, Stärke der Abdeckplatte und der Zwischenablage ist 2,5 mm. Montage ohne Werkzeug.

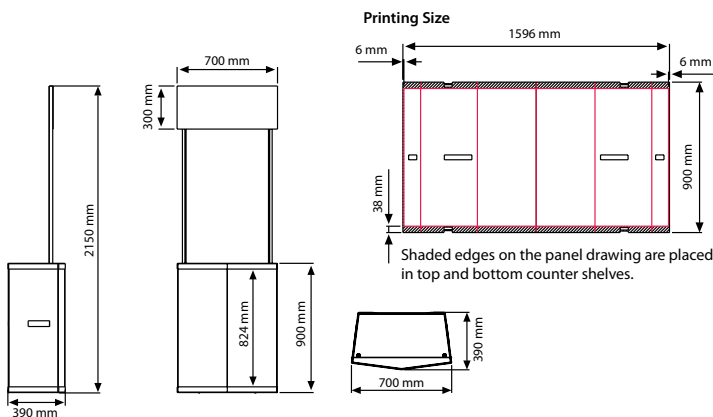

MATERIAL : Plastic				WEIGHT	PACKING SIZE
ARTICLE	DESCRIPTION	PANEL SIZE	COPY SIZE	WITH PACKING	*W X H X D
UTS00N3000	Without bag	1596 X 900 mm	1584 X 824 mm	12,220 kg	450 X 1000 X 170 mm
UTS00N3100	With bag	1596 X 900 mm	1584 X 824 mm	12,740 kg	450 X 1000 X 170 mm







*W:Width H: Height D: Depth

Rectangular Promostand



This simple counter is suitable for all kind of promotion events for retail promotions such as exhibitions, supermarkets, demonstrations. Rectangular Promostand is a stock saving product. Ledge Rectangular Promostand that gives more space for item promoted. Header Rectangular Promostand allows for personalizing and helps the brand and promotion to be seen from a distance. Also offered with a choice of felt fabric in grey.

Diese einfache Theke ist geeignet für alle Arten von Events, Promotions, Ausstellungen, Messen, Einzelhandel, Demonstrationen. Der Rectangular Promostand ist ein platz sparender Lagerartikel. Der Ladder Rectangular Promostand ist ideal geeignet für Produktpräsentationen. Der Header Rectangular Promostand ist durch das aufgebrachte Logo ideal um Aufmerksamkeit zu ziehen. Der Rectangular Promostand with Pole System bietet eine Vielzahl an Variationen mit Prospekthaltern, Postern und Logo. Abgerundet wird es mit einem optionalen grauen Filz in Grau.

-  Packed unassembled with an easy-to-understand instruction sheet. Demontiert verpackt mit einer einfachen Gebrauchsanleitung.
-  Flat - pack design. Flach verpackt.
-  Inner shelf, header, carry bag, brochure holders excluded. See Free Standing System pages for more accessory options. Regale, Topschild, Tragetasche, Prospekthalter nicht inkludiert. Sehen Sie auf den Free Stanging Katalogseiten nach für mehr Zubehör.
-  2 packs. See info chart for pack sizes. 2 Packungen. Siehe Infodiagramm für Packungsgrößen.



10 mm Multiwall PP

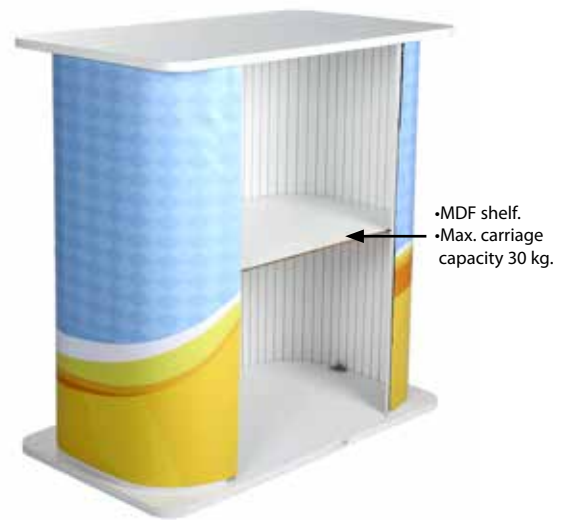

Don't forget to order separately

- Inner shelf
- Grey felt
- Carry bag
- Header
- Ledge

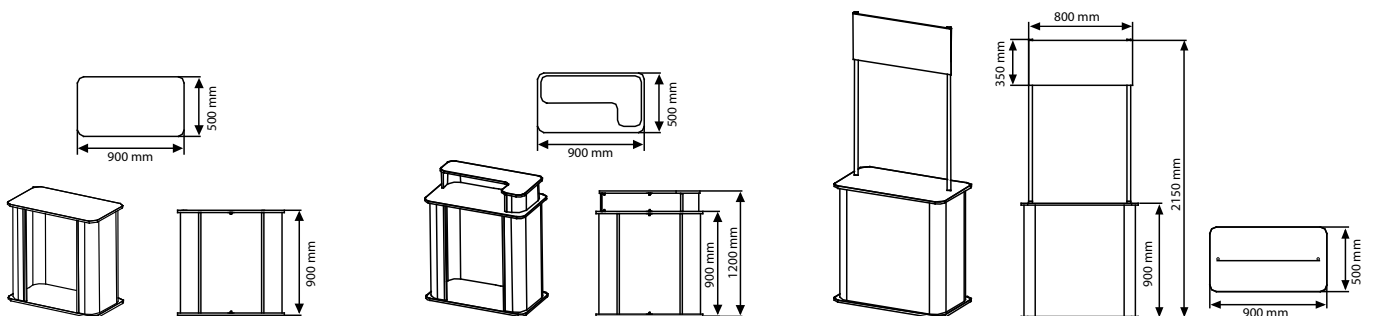



Rectangular Ledge Promostand



10 mm
Multiwall PP

•Hard white top plate
•Max. carriage
capacity 70 kg.



•Hard white top
plate.
•Max. carriage
capacity 70 kg.

•MDF shelf.
•Max. carriage
capacity 30 kg.



Rectangular Promostand with Header

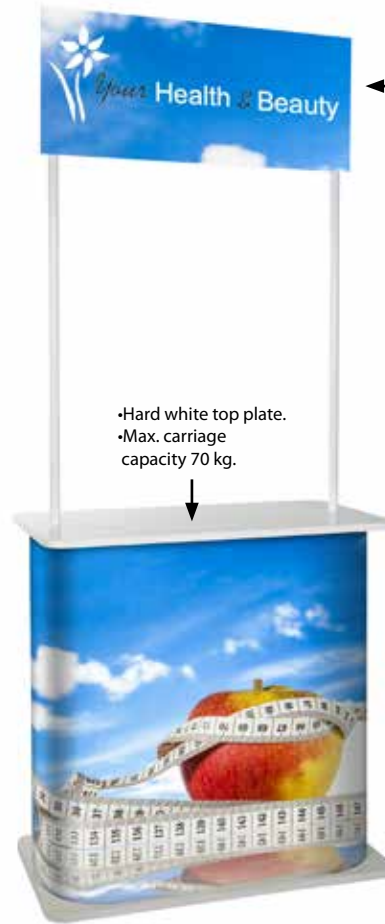

3 mm
PVC Foam

•Hard white top plate.
•Max. carriage
capacity 70 kg.

Don't forget to order
separately
• Inner shelf
• Grey felt
• Carry bag
• Header
• Ledge

Strong & elegant
powder coated
steel pipes

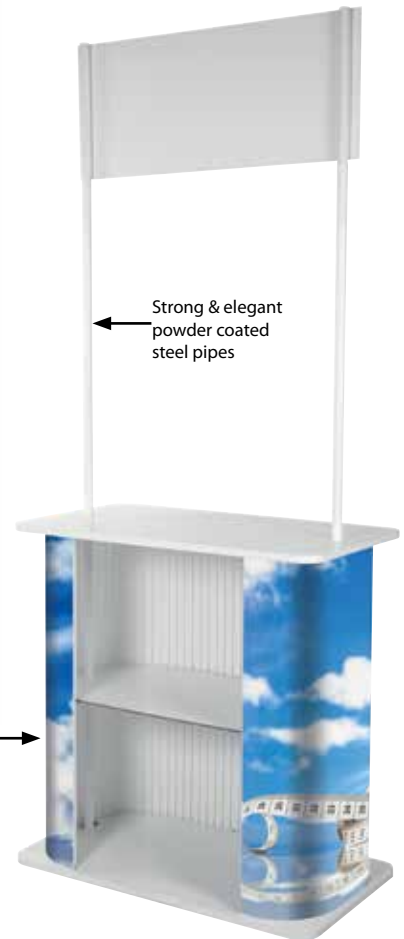

10 mm
Multiwall PP



UYPOTS1050
Carry bag



UYPOTS0030
Velcro Roll with double
sided tape 18 meters.



UYPOTS003G
Grey felt only for
Rectangular Promostand
incl. Velcro set for 900 mm.

MATERIAL : Plastic				WEIGHT	PACKING SIZE
ARTICLE	DESCRIPTION	PANEL SIZE	PRINTING SIZE	WITH PACKING	*W X H X D
UTSD000909	w/out bag,w/out felt,w/out shelf	1849 X 892 mm	1815 X 865 mm	11,500 kg	535 X 940 X 70 / 200 X 940 X 200 mm
UTSD020909	with header,w/out bag,w/out felt,w/out shelf	1849 X 892 mm	1815 X 865 mm	14,300 kg	535 X 940 X 95 / 200 X 1240 X 200 mm
UTSD010912	Ledge w/out bag,w/out felt,w/out shelf	1849 X 892 mm	1815 X 865 mm	14,500 kg	570 X 1040 X 95 / 200 X 940 X 200 mm
UYPOTS0010	Inner shelf only,white	850 X 450 mm		1,750 kg	855 X 455 X 7 mm
UYPOTS0020	Inner shelf only for header ,white	850 X 450 mm		1,750 kg	855 X 455 X 7 mm
UYPOTS003G	Grey felt only incl.Velcro.	1875 X 865 mm	1875 X 865 mm	0,360 kg	250 X 250 X 100 mm

* W:Width H: Height D: Depth



Circle Promostand



This round counter is suitable for all kind of promotion events for retail promotions such as exhibitions, supermarkets, demonstrations. Round shape takes attention and gives more space for visitors to examine items presented. Circle Promostand is a stock saving product. Keeping components available in stock as flat-pack, it enables to offer numerous of variations. Ledge Circle Promostand that gives more space for item promoted. Header Circle Promostand allows for personalizing and helps the brand and promotion to be seen from a distance. Also offered with a choice of felt fabric in grey.

Diese runde Theke ist geeignet für alle Arten von Events, Promotions, Ausstellungen, Messen, Einzelhandel, Demonstrationen. Die runde Form bietet mehr Platz für die auszustellenden Artikel. Hergestellt aus PP und einer MDF Ablage. Der Round Counter ist ein Platz sparender Lagerartikel. Das Zubehör ist auch flach verfügbar. Der Ladder Round Promostand ist ideal geeignet für Produktpräsentationen. Der Header Round Promostand ist durch das aufgebrachte Logo ideal um Aufmerksamkeit zu ziehen. Der Round Promostand with Pole System bietet eine Vielzahl an Variationen mit Prospekthaltern, Postern und Logo. Abgerundet wird es mit einem optionalen grauen Filz in Grau.



Packed unassembled with an easy-to-understand instruction sheet. Demontiert verpackt mit einer einfachen Gebrauchsanleitung.



Flat-pack design. Flach verpackt.



Inner shelf, header, carry bag, brochure holders excluded. See Free Standing System pages for more accessory options. Regale, Toppschild, Tragetasche, Prospekthalter nicht inkludiert. Sehen Sie auf den Free Standing Katalogseiten nach für mehr Zubehör.



2 packs. See info chart for pack sizes. 2 Packungen. Siehe Infodiagramm für Packungsgrößen.



Don't forget to order separately

- Inner shelf
- Grey felt
- Carry bag
- Header
- Ledge

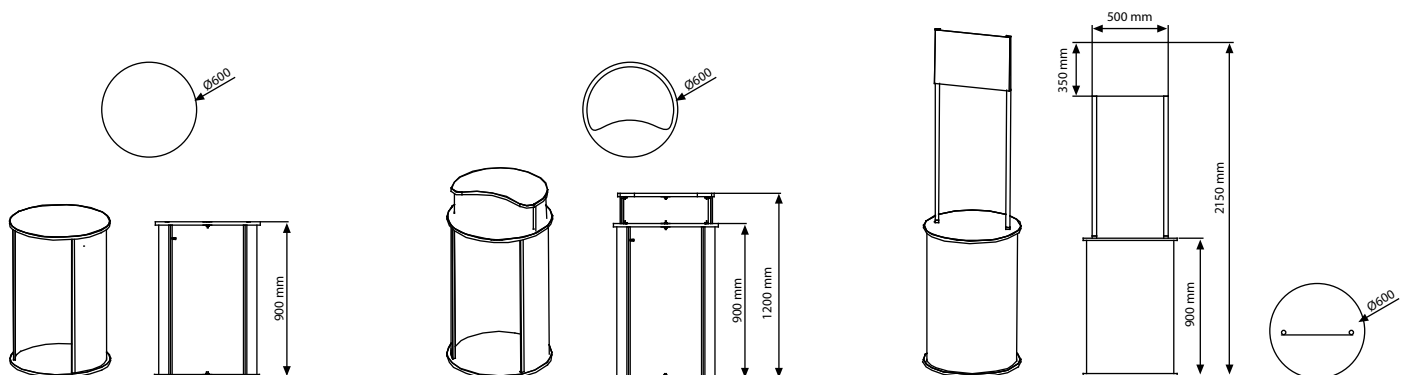



Circle Ledge Promostand



•Hard white top plate.
•Max. carriage capacity 70 kg.

10 mm Multiwall PP

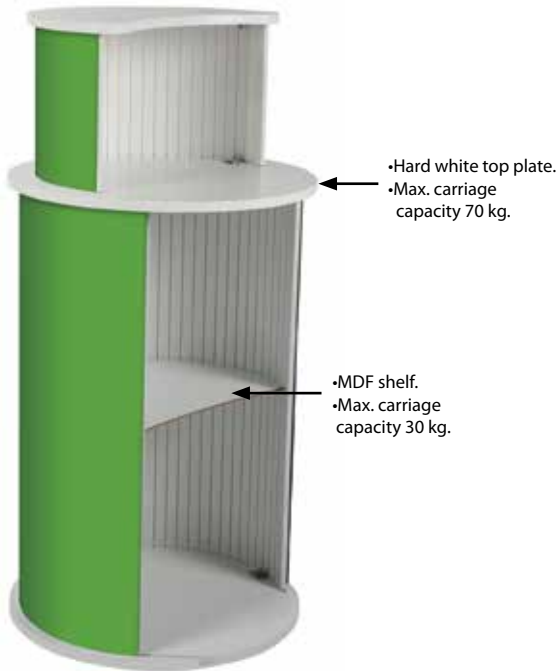

•Hard white top plate.
•Max. carriage capacity 70 kg.

•MDF shelf.
•Max. carriage capacity 30 kg.



Circle Promostand with Header



3 mm PVC Foam

Strong & elegant powder coated steel pipes

•Hard white top plate.
•Max. carriage capacity 70 kg.

10 mm Multiwall PP

Max. carriage capacity 30 kg.

Don't forget to order separately

- Inner shelf
- Grey felt
- Carry bag
- Header
- Ledge



UYPOTS3050 Carry bag



UYPOTS0030 Velcro Roll with double sided tape 18 meters.



UYPOTSR03G Grey felt only for Circle Promostand incl. Velcro set for 900 mm.

MATERIAL : Plastic				WEIGHT	PACKING SIZE
ARTICLE	DESCRIPTION	PANEL SIZE	PRINTING SIZE	WITH PACKING	*W X H X D
UTSR000609	w/out bag,w/out felt,w/out shelf	1238 X 892 mm	1204 X 865 mm	7,500 kg	630 X 630 X 70 / 200* X 940 X 200 mm
UTSR020609	with header,w/out bag,w/out felt,w/out shelf	1238 X 892 mm	1204 X 865 mm	10,200 kg	630 X 630 X 95 / 200 X 1040 X 200 mm
UTSR010612	Ledge w/out bag,w/out felt,w/out shelf	1238 X 892 mm	1204 X 865 mm	9,700 kg	630 X 630 X 95 / 200 X 1240 X 200 mm
UYPOTSR010	Inner shelf only,white	550 X 415 mm		0,900 kg	555 X 420 X 7 mm
UYPOTSR020	Inner shelf only for header,white	550 X 415 mm		0,900 kg	555 X 420 X 7 mm
UYPOTSR03G	Grey felt only incl.Velcro.	1255 X 865 mm	1255 X 865 mm	0,310 kg	250 X 250 X 100 mm

*W:Width H: Height D: Depth



Bean Promostand



This contemporary counter is suitable for all kind of promotion events for retail promotions such as exhibitions, supermarkets, demonstrations. Bean Promostand is a stock saving product. Keeping components available in stock as flat-pack, it enables to offer numerous of variations. Ladder Bean Promostand that gives more space for item promoted. Header Bean Promostand allows for personalizing. Also offered with a choice of felt fabric in grey.

Diese zeitgenössische Theke ist geeignet für alle Arten von Events, Promotions, Ausstellungen, Messen, Einzelhandel, Demonstrationen. Der Bean Promostand ist ein platz sparender Lagerartikel. Das Zubehör ist auch flach verfügbar, sodass man diese Artikel als Lagerartikel führen kann. Der Ladder Bean Promostand ist ideal geeignet für Produktpräsentationen. Der Header Bean Promostand ist durch das aufgebrachte Logo ideal um Aufmerksamkeit zu ziehen. Der Bean Promostand with Pole System bietet eine Vielzahl an Variationen mit Prospekthaltern, Postern und Logo. Abgerundet wird es mit einem optionalen grauen Filz in Grau.

- Packed unassembled with an easy-to-understand instruction sheet. Demontiert verpackt mit einer einfachen Gebrauchsanleitung.
- Flat-pack design. Flach verpackt.
- Inner shelf, header, carry bag, brochure holders excluded. See Free Standing System pages for more accessory options. Regale, Toppschild, Tragetasche, Prospekthalter nicht inkludiert. Sehen Sie auf den Free Standing Katalogseiten nach für mehr Zubehör.
- 2 packs. See info chart for pack sizes. 2 Packungen. Siehe Infodiagramm für Packungsgrößen.

Don't forget to order separately

- Inner shelf
- Grey felt
- Carry bag
- Header
- Ledge

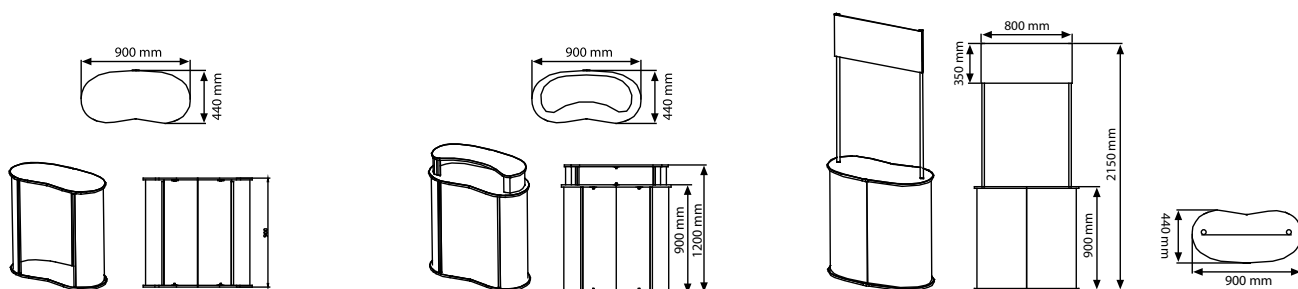



Bean Ledge Promostand



10 mm
Multiwall PP

•Hard white top plate.
•Max. carriage
capacity 70 kg.



•Hard white top plate.
•Max. carriage
capacity 70 kg.

•MDF shelf.
•Max. carriage
capacity 30 kg.

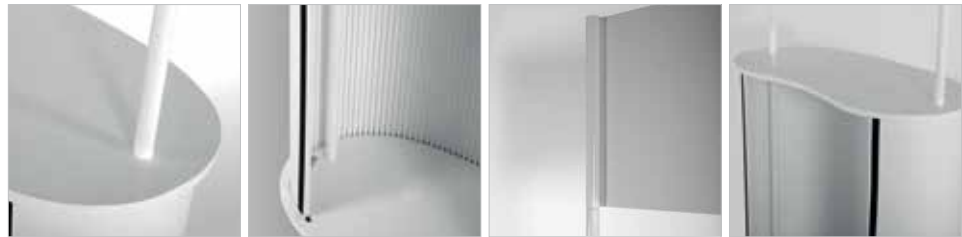

Bean Promostand with Header

Don't forget to order
separately
• Inner shelf
• Grey felt
• Carry bag
• Header
• Ledge



•Hard white top plate.
•Max. carriage
capacity 70 kg.

Strong & elegant
powder coated
steel pipes

3 mm
PVC Foam



•MDF shelf.
•Max. carriage
capacity 30 kg.

10 mm
Multiwall PP



UYPOTS1050
Carry bag

MATERIAL : Plastic				WEIGHT	PACKING SIZE
ARTICLE	DESCRIPTION	PANEL SIZE	PRINTING SIZE	WITH PACKING	*W X H X D
UTSB000909	w/out bag,w/out felt,w/out shelf	1557 X 892 mm	1523 X 865 mm	9,500 kg	470 X 940 X 70 / 200 X 940 X 200 mm
UTSB020909	with header,w/out bag,w/out felt,w/out shelf	1557 X 892 mm	1523 X 865 mm	12,200 kg	470 X 940 X 95 / 200 X 1240 X 200 mm
UTSB010912	Ledge w/out bag,w/out felt,w/out shelf	1557 X 892 mm	1523 X 865 mm	12,300 kg	510 X 1040 X 95 / 200 X 940 X 200 mm
UYPOTS010	Inner shelf only,white	855 X 381 mm		1,200 kg	860 X 386 X 7 mm
UYPOTS020	Inner shelf only for header ,white	855 X 381 mm		1,200 kg	860 X 386 X 7 mm
UYPOTS03G	Grey felt only incl.Velcro.	1570 X 865 mm	1575 X 865 mm	0,340 kg	250 X 250 X 100 mm

* W:Width H: Height D: Depth



UYPOTS0030
Velcro Roll with double
sided tape 18 meters.



UYPOTS03G
Grey felt only for Bean
Promostand incl.
Velcro set for 900 mm.



Seed Promostand



Seed Promostand is suitable for all kind of promotion events for retail promotions such as exhibitions, supermarkets, demonstrations. With its unique seed shape, it takes attention and occupies small place where it stands. Seed Promostand is a stock saving product. Ledge Seed Promostand that gives more space for item promoted. Header Seed Promostand allows for personalizing. Seed Promostand with Pole System offers choice of shelves, banners, and header. Also offered with a choice of felt fabric in grey.

Der Seed Promostand ist geeignet für alle Arten von Werbeveranstaltungen, Einzelhandelsaktionen wie Ausstellungen, Supermärkte und Demonstrationen. Mit seiner einzigartigen Form zieht er sofort die Aufmerksamkeit auf sich und besetzt nur sehr wenig Platz. Das Produkt ist sehr platzsparend im Lager. Der Ladder Seed Promostand ist ideal geeignet für Produktpräsentationen. Der Header Seed Promostand ist durch das aufgebrachte Logo ideal um Aufmerksamkeit zu ziehen. Der Seed Promostand with Pole System bietet eine Vielzahl an Variationen mit Prospekthaltern, Postern und Logo. Abgerundet wird es mit einem optionalen grauen Filz in Grau.



Packed unassembled with an easy-to-understand instruction sheet. Demontiert verpackt mit einer einfachen Gebrauchsanleitung.



Flat - pack design. Flach verpackt.



Inner shelf, header, carry bag, brochure holders excluded. See Free Standing System pages for more accessory options. Regale, Toppschild, Tragetasche, Prospekthalter nicht inkludiert. Sehen Sie auf den Free Standing Katalogseiten nach für mehr Zubehör.



2 packs. See info chart for pack sizes. 2 Packungen. Siehe Infodiagramm für Packungsgrößen.

Don't forget to order separately

- Inner shelf
- Grey felt
- Carry bag
- Header
- Ledge

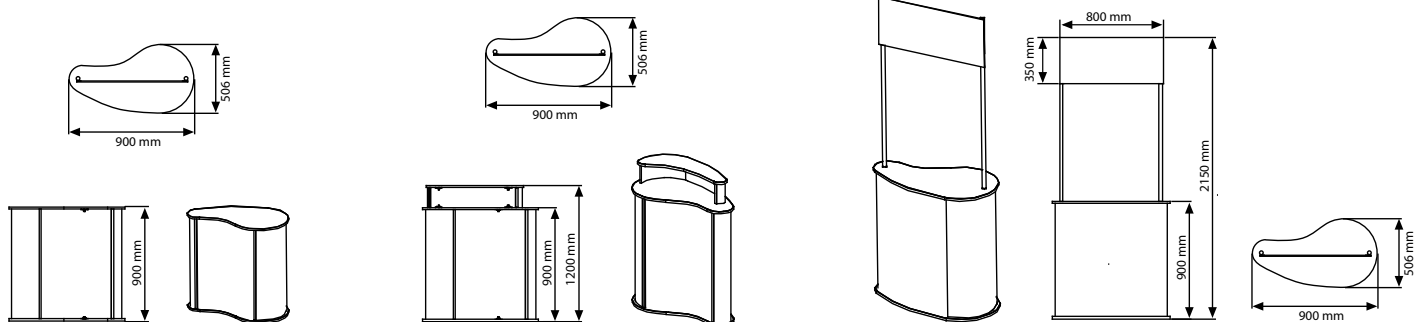



Seed Ledge Promostand

- Hard white top plate.
- Max. carriage capacity 70 kg.



10 mm
Multiwall PP

- Hard white top plate.
- Max. carriage capacity 70 kg.



Max. carriage capacity 30 kg.



UYPOTS0030
Velcro Roll with double sided tape 18 meters.



UYPOTSC03G
Grey felt only for Seed Promostand incl. Velcro set for 900 mm.



Seed Promostand with Header



3 mm
PVC Foam

- Hard white top plate.
- Max. carriage capacity 70 kg.



UYPOTS1050
Carry bag

Don't forget to order separately

- Inner shelf
- Grey felt
- Carry bag
- Header
- Ledge



Strong & elegant powder coated steel pipes

Max. carriage capacity 30 kg.

MATERIAL : Plastic				WEIGHT		PACKING SIZE	
ARTICLE	DESCRIPTION	PANEL SIZE	PRINTING SIZE	WITH PACKING	*W X H X D		
UTSC000909	w/out bag,w/out felt,w/out shelf	1530 X 892 mm	1496 X 865 mm	8,200 kg	535 X 940 X 70	200 X 940 X 200 mm	
UTSC020909	with header,w/out bag,w/out felt,w/out shelf	1530 X 892 mm	1496 X 865 mm	11,000 kg	535 X 940 X 95	200 X 1240 X 200 mm	
UTSC010912	Ledge w/out bag,w/out felt,w/out shelf	1530 X 892 mm	1496 X 865 mm	9,500 kg	570 X 1040 X 95	200 X 940 X 200 mm	
UYPOTSC010	Inner shelf only,white	850 X 444 mm		1,000 kg	855 X 449 X 7 mm		
UYPOTSC020	Inner shelf only for header ,white	850 X 444 mm		1,000 kg	855 X 449 X 7 mm		
UYPOTSC03G	Grey felt only incl.Velcro.	1555 X 865 mm	1555 X 865 mm	0,340 kg	250 X 250 X 100 mm		
UTSC030909	Pole system,w/out bag or felt or shelf or header	1555 X 892 mm	1521 X 865 mm	10,800 kg	535 X 940 X 70	205 X 1320 X 145 mm	
UYPOTSC040	Header only for pole system	300 X 500 mm	300 X 500 mm	0,500 kg	320 X 510 X 30 mm		
UYPOTSP010	Inner shelf only for pole system,White	873 X 444 mm		1,150 kg	878 X 449 X 7 mm		
UYPOTSP03G	Grey felt only for pole system incl.Velcro	1575 X 865 mm	1575 X 865 mm	0,350 kg	250 X 250 X 100 mm		

*W:Width H: Height D: Depth



Variations & Seed Promostand with Pole System

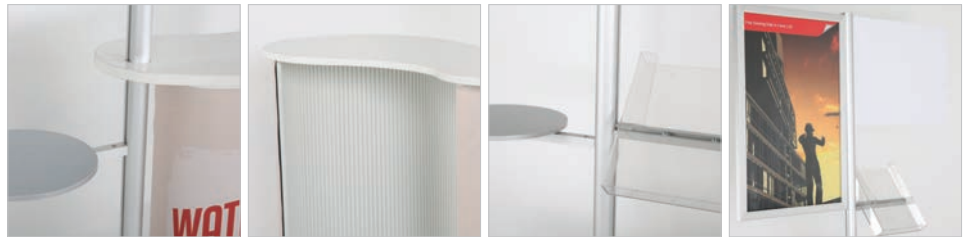

Make up your stand to fit your own wishes!



Mix and match your own stand!

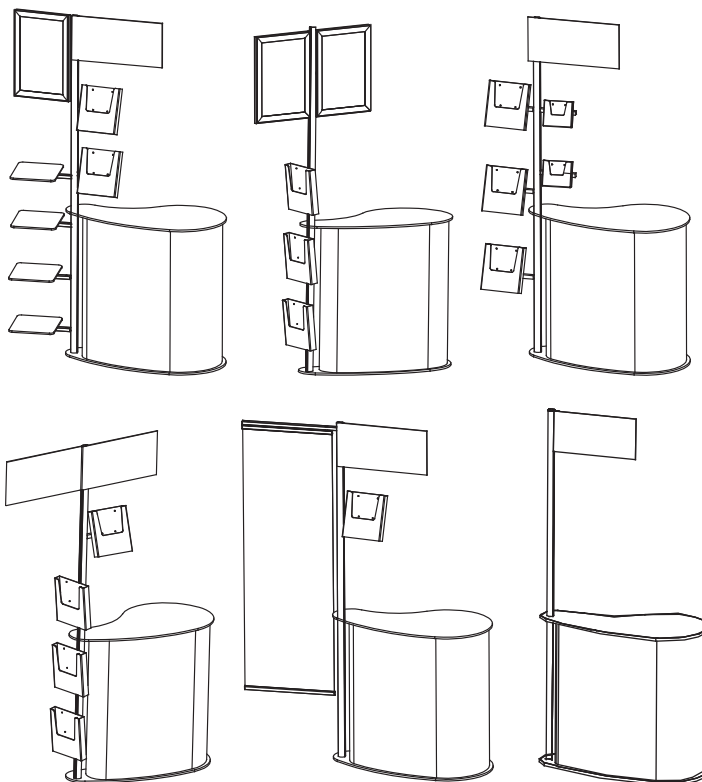

- Don't forget to order separately**
- Inner shelf
 - Grey felt
 - Carry bag
 - Header
 - Ladder
 - Circle & square shelves
 - Leaflet holders
 - Slide-in frames
 - Banner holder



UYP0TS0030
Velcro Roll with double sided tape 18 meters.



UYP0TP03G
Grey felt only for Seed Promostand with Pole System incl. Velcro set for 900 mm.



UYP0TS2050 / Carry bag

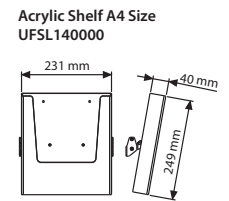

Acrylic Shelf A4 Size
UFSL140000

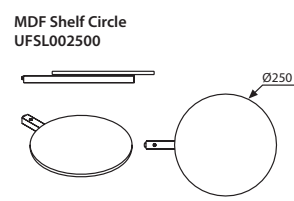

MDF Shelf Circle
UFSL002500

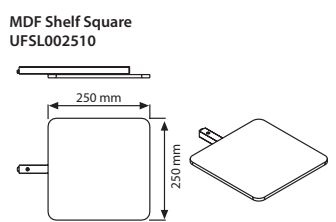

MDF Shelf Square
UFSL002510